

A x B	L	Serrage Spannsystem Clamping	Art. N°	Art. N°
6 x 6	115	A	710-6	-
7 x 7	115	A	710-7	720-7
8 x 8	115	A	710-8	720-8
8 x 8	140	A	710-8-140	-
10 x 10	115	A	710-10	720-10
12 x 12	130	A	710-12	720-12

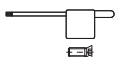

Chaque support est livré avec vis et clé.
 Jeder Halter wird mit Spannschraube(n) und Schlüssel geliefert.
 Screw(s) and key are included with each tool holder.

Porte-outils en métal lourd anti-vibratoire
 Schwingungsdämpfende Schwermetallhalter
 Low vibration heavy metal holders

710-NOVIBRA

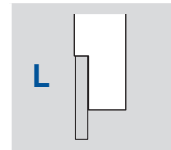
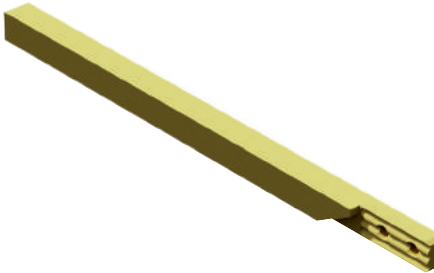
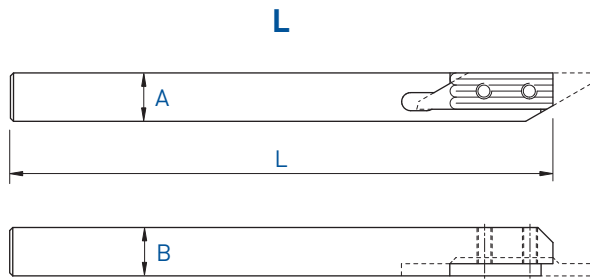

A x B	L	Serrage Spannsystem Clamping	Art. N°
6 x 6	115	A	710-6-NOVIBRA
7 x 7	115	A	710-7-NOVIBRA
8 x 8	115	A	710-8-NOVIBRA



Chaque support est livré avec vis et clé.
 Jeder Halter wird mit Spannschraube(n) und Schlüssel geliefert.
 Screw(s) and key are included with each tool holder.

L

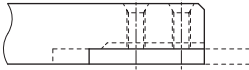
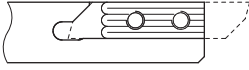

R

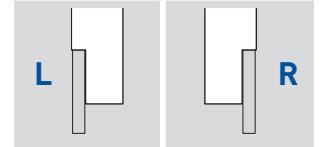
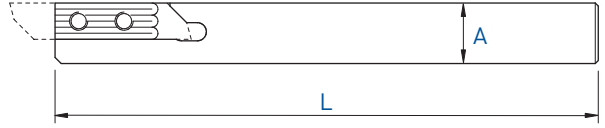

Serrage standard A
Standard Spannsystem A
Standard clamping system A

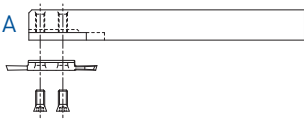

Serrage B
Spannsystem B
Clamping system B

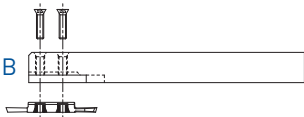

A x B	L	Serrage Spannsystem Clamping	Art. N°	Art. N°
7 x 7	115	A	730-7	740-7
8 x 8	115	A + B	730-8	740-8
8 x 8	140	A + B	730-8-140	-
10 x 10	115	A + B	730-10	740-10
10 x 10	50	A + B	730-10-50	740-10-50
12 x 12	130	A + B	730-12	740-12
12 x 12	90	A + B	730-12-90	740-12-90
12.7 x 12.7	130	A + B	730-12.7	740-12.7
16 x 16	130	A + B	730-16	740-16
16 x 16	75	A + B	730-16-75	740-16-75
20 x 20	120	A + B	730-20	740-20

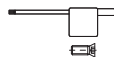

Chaque support est livré avec vis et clé.
Jeder Halter wird mit Spannschraube(n) und Schlüssel geliefert.
Screw(s) and key are included with each tool holder.



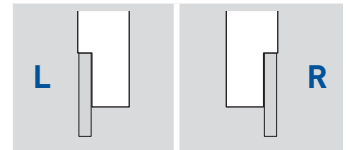
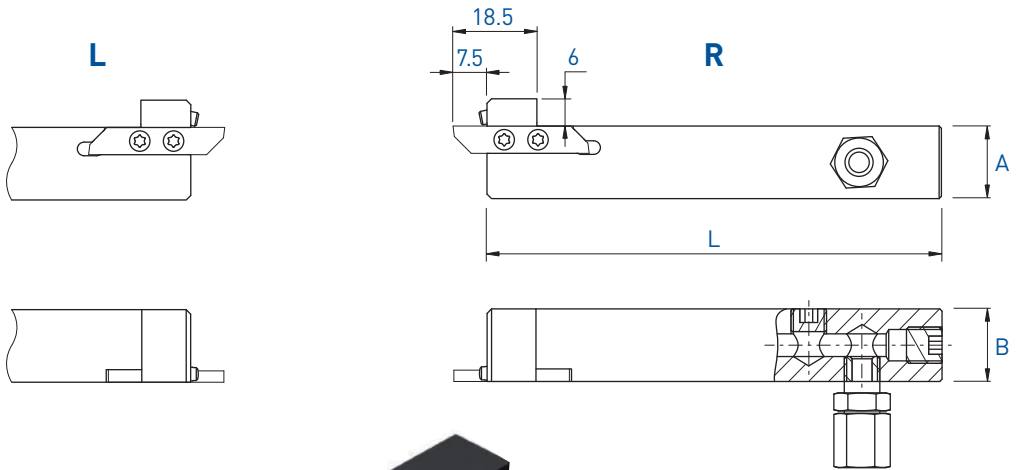

Porte-outils avec arrosage intégré
 Halter mit integrierter Kühlmittelzufuhr
 Holders with integrated coolant supply

730-JET / 740-JET

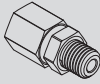

A x B	L	Serrage Spannsystem Clamping	Art. N°	Art. N°
8 x 10	100	A + B	-	740-0810-JET
10 x 12	100	A + B	730-1012-JET	740-1012-JET
10 x 12	80	A + B	-	740-1012-80-JET new
12 x 12	100	A + B	730-12-JET	740-12-JET
12.7 x 12.7	100	A + B	730-12.7-JET	740-12.7-JET
16 x 16	100	A + B	730-16-JET	740-16-JET
20 x 20	100	A + B	730-20-JET	740-20-JET



Pièces de rechange Ersatzteile Spare parts			Buse Düse Nozzle 	Option 
	Art. N°	Art. N°	Art. N°	Art. N°
740-0810-JET	J-M5-D5	JB-M5	-	JC-M5-D5
730-JET / 740-JET	J-M8X1-D6	JB-M8X1	JJ-M3X6-D1.5	-

Chaque support est livré avec vis et clé.
 Jeder Halter wird mit Spannschraube(n) und Schlüssel geliefert.
 Screw(s) and key are included with each tool holder.



R

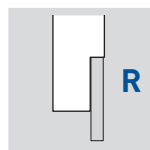
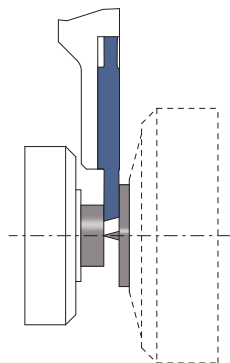
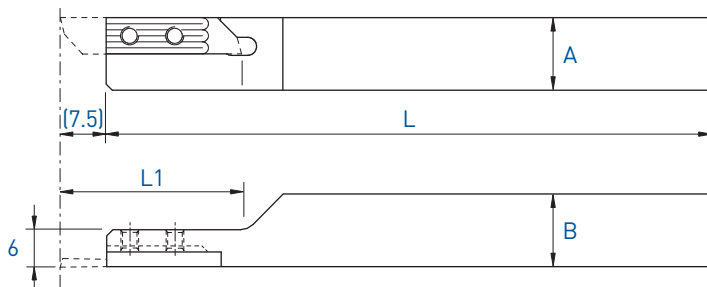

A x B	L	L1	Serrage Spannsystem Clamping	Art. N°
8 x 8	115	24	A	740-C-8
10 x 10	115	24	A	740-C-10
12 x 12	130	30	A	740-C-12
16 x 16	130	40	A	740-C-16

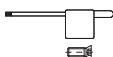

Chaque support est livré avec vis et clé.
Jeder Halter wird mit Spannschraube(n) und Schlüssel geliefert.
Screw(s) and key are included with each tool holder.

Porte-outils

Halter

Holders

Coupe à droite déportée

Versetztes Rechtsschneiden

Right cut off line

730RC

Utiliser des plaquettes type 731R
 WSP Typ 731R verwenden
 Use inserts type 731R

Voir pages 1.39 - 1.45
 Siehe Seiten 1.39 - 1.45
 See pages 1.39 - 1.45

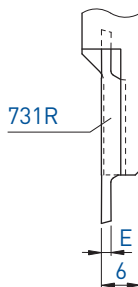
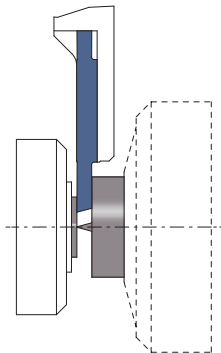
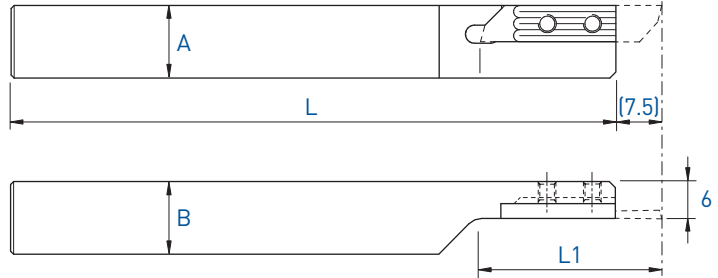

L (R)

Coupe à droite déportée
 Versetztes Rechtsschneiden
 Right cut off line



A x B	L	L1	Art. N°
8 x 8	115	24	730RC-8
10 x 10	115	24	730RC-10
12 x 12	130	30	730RC-12
16 x 16	130	40	730RC-16



Chaque support est livré avec vis et clé.
 Jeder Halter wird mit Spannschraube(n) und Schlüssel geliefert.
 Screw(s) and key are included with each tool holder.

TOP-LINE

Porte-outils en métal lourd anti-vibratoire
 Schwingungsdämpfende Schwermetallhalter
 Low vibration heavy metal holders

730-NOVIBRA
 740-NOVIBRA

L

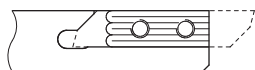

R

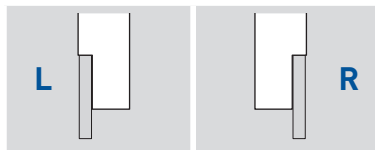
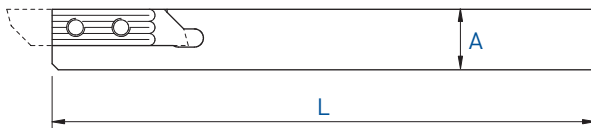

A x B	L	Serrage Spannsystem Clamping	Art. N°	Art. N°
7 x 7	115	A	730-7-NOVIBRA	740-7-NOVIBRA
8 x 8	115	A + B	730-8-NOVIBRA	740-8-NOVIBRA
8 x 8	80	A + B	-	740-8-80-NOVIBRA
10 x 10	115	A + B	-	740-10-NOVIBRA
12 x 12	130	A + B	-	740-12-NOVIBRA

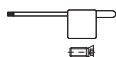

Chaque support est livré avec vis et clé.
 Jeder Halter wird mit Spannschraube(n) und Schlüssel geliefert.
 Screw(s) and key are included with each tool holder.

Porte-outils

Halter

Holder

740 / 730-D

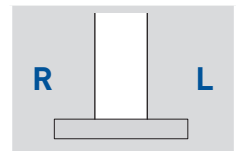
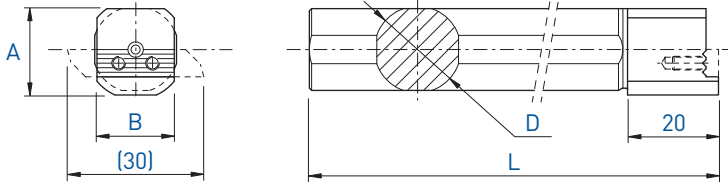

A x B	L	D	Art. N°
19 x 17	160	16	740/730-D16
19 x 17	160	19.05	740/730-D19.05
19 x 17	110	19.05	740/730-D19.05-S
19.5 x 17	160	20	740/730-D20
20 x 17	110	22	740/730-D22
22 x 17	200	25	740/730-D25
22 x 17	200	25.4	740/730-D25.4

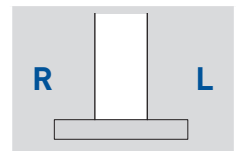
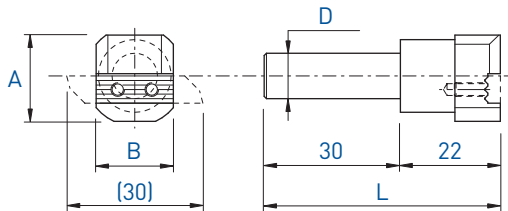

A x B	L	D	Art. N°
19 x 17	52	10	740/730-D10

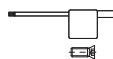

Chaque support est livré avec vis et clé.
 Jeder Halter wird mit Spannschraube(n) und Schlüssel geliefert.
 Screw(s) and key are included with each tool holder.

L

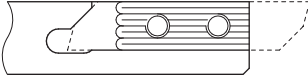

R

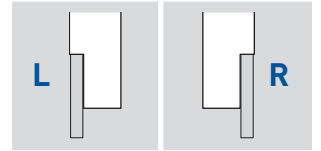
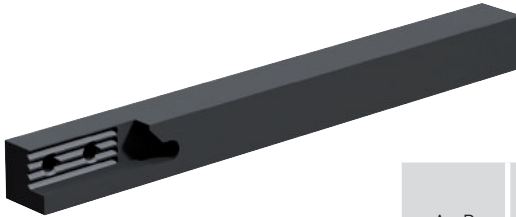
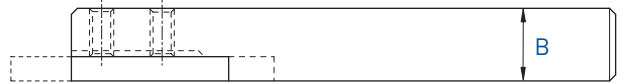
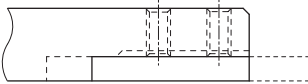
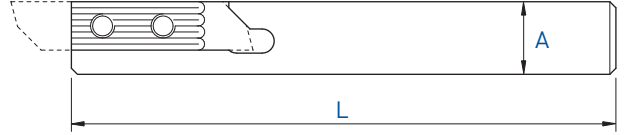

Serrage standard A
Standard Spannsystem A
Standard clamping system A

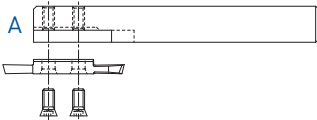

A x B	L	Serrage Spannsystem Clamping	Art. N°	Art. N°
10 x 10	115	A	750-10	760-10
10 x 10	115	A + B	750-10-AB	760-10-AB
10 x 10	50	A	750-10-50	760-10-50
12 x 12	130	A	750-12	760-12
12 x 12	130	A + B	750-12-AB	760-12-AB
12 x 12	90	A	750-12-90	760-12-90
12 x 12	90	A + B	750-12-90-AB	760-12-90-AB
12.7 x 12.7	130	A + B	750-12.7	760-12.7
14 x 14	130	A + B	750-14	760-14
16 x 16	130	A + B	750-16	760-16
16 x 16	75	A + B	750-16-75	760-16-75
20 x 20	120	A + B	750-20	760-20
25 x 25	140	A	760/750-25	

Serrage A + B
Spannsystem A + B
Clamping system A + B

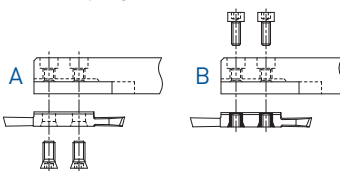

760/750-25
R + L



Chaque support est livré avec vis et clé.
Jeder Halter wird mit Spannschraube(n) und Schlüssel geliefert.
Screw(s) and key are included with each tool holder.

Porte-outils avec arrosage intégré
 Halter mit integrierter Kühlmittelzufuhr
 Holders with integrated coolant supply

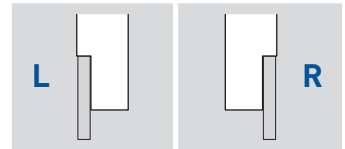
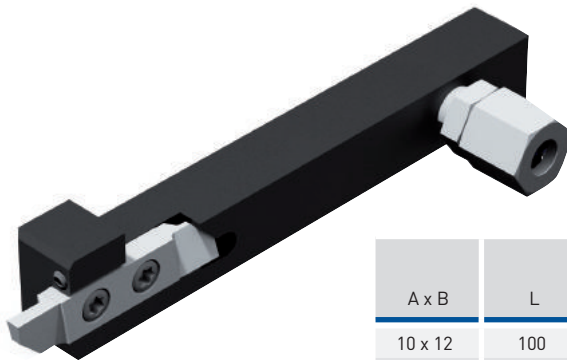
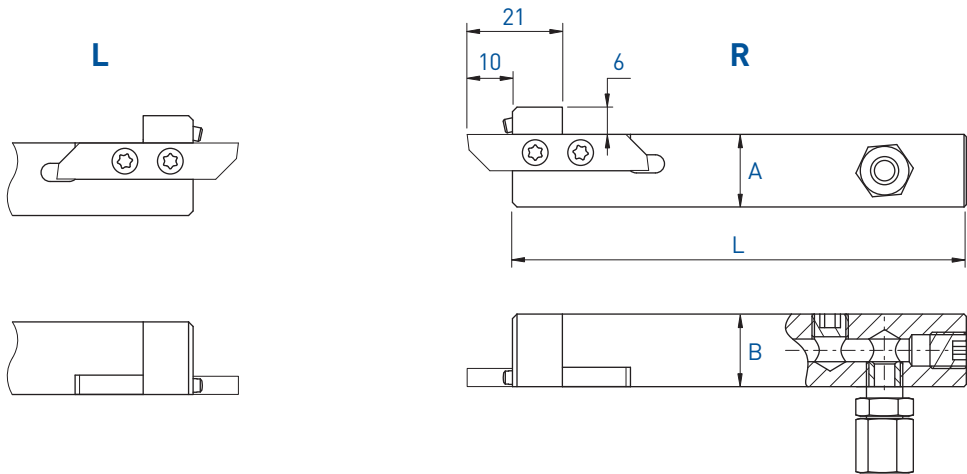

750-JET / 760-JET

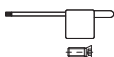

A x B	L	Serrage Spannsystem Clamping	Art. N°	Art. N°
10 x 12	100	A + B	750-1012-JET	760-1012-JET
10 x 12	80	A + B	-	760-1012-80-JET new
12 x 12	100	A + B	750-12-JET	760-12-JET
12.7 x 12.7	100	A + B	750-12.7-JET	760-12.7-JET
16 x 16	100	A + B	750-16-JET	760-16-JET
20 x 20	100	A + B	750-20-JET	760-20-JET

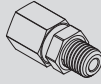

Chaque support est livré avec vis et clé.
 Jeder Halter wird mit Spannschraube(n)
 und Schlüssel geliefert.
 Screw(s) and key are included with each
 tool holder.

Pièces de rechange Ersatzteile Spare parts			Buse Düse Nozzle 
	Art. N°	Art. N°	Art. N°
750-JET / 760-JET	J-M8X1-D6	JB-M8X1	JJ-M3X6-D1.5

Porte-outils
Halter
Holder

Coupe à droite déportée
Versetztes Rechtsschneiden
Right cut off line

750RC

Utiliser des plaquettes type 751R
 WSP Typ 751R verwenden
 Use inserts type 751R

Voir pages 1.88 - 1.99
 Siehe Seiten 1.88 - 1.99
 See pages 1.88 - 1.99

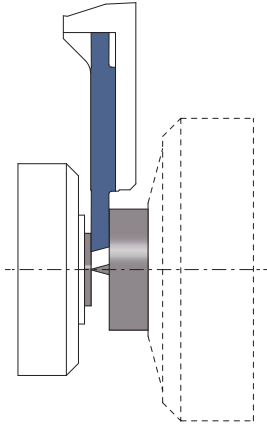
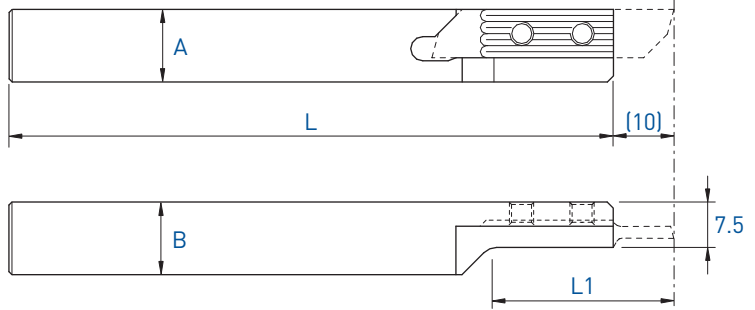

L (R)			
Coupe à droite déportée Versetztes Rechtsschneiden Right cut off line			
A x B	L	L1	Art. N°
12 x 12	130	30	750RC-12
16 x 16	130	40	750RC-16

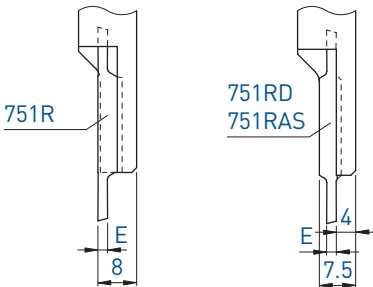

(p. 1.98 - 1.99)



Chaque support est livré avec vis et clé.
 Jeder Halter wird mit Spanschraube(n) und Schlüssel geliefert.
 Screw(s) and key are included with each tool holder.

Porte-outils

Halter

Holder

Coupe à gauche déportée

Versetztes Linksschneiden

Left cut off line

760LC

Utiliser des plaquettes type 761L
WSP Typ 761L verwenden
Use insets type 761L

Voir pages 1.88 - 1.94 + 1.98
Siehe Seiten 1.88 - 1.94 + 1.98
See pages 1.88 - 1.94 + 1.98

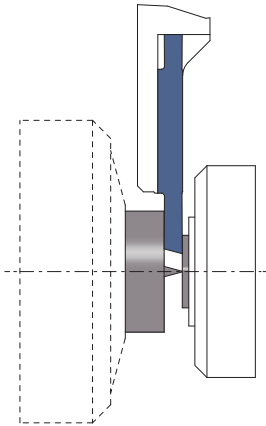
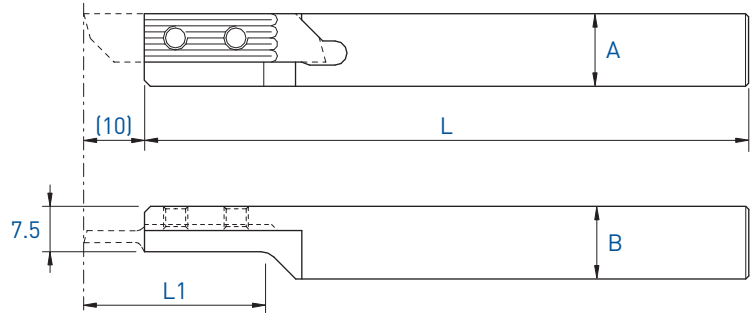

R (L)

Coupe à gauche déportée
Versetztes Linksschneiden
Left cut off line

A x B	L	L1	Art. N°
16 x 16	130	40	760LC-16

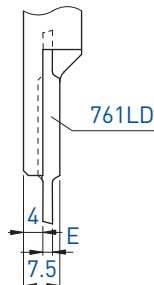
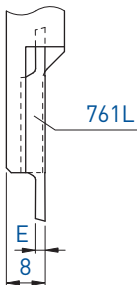

(p. 1.98)



Chaque support est livré avec vis et clé.
Jeder Halter wird mit Spannschraube(n) und Schlüssel geliefert.
Screw(s) and key are included with each tool holder.

R

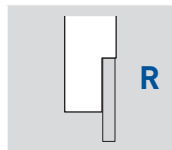
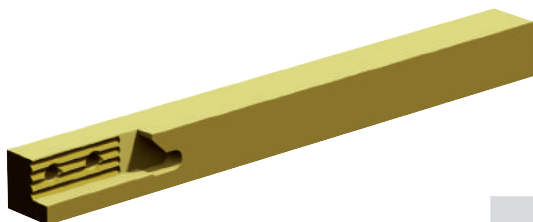
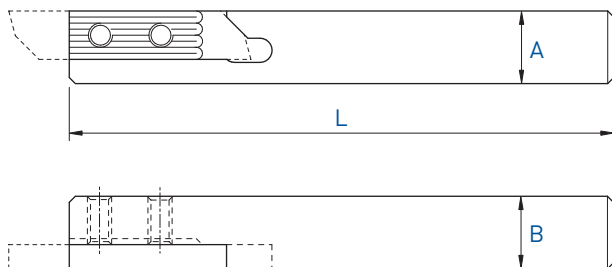

A x B	L	Serrage Spannsystem Clamping	Art. N°
10 x 10	115	A	760-10-NOVIBRA
12 x 12	130	A	760-12-NOVIBRA

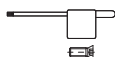

Chaque support est livré avec vis et clé.
 Jeder Halter wird mit Spannschraube(n) und Schlüssel geliefert.
 Screw(s) and key are included with each tool holder.

Porte-outils

Halter

Holders

760 / 750-D10

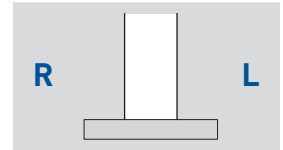
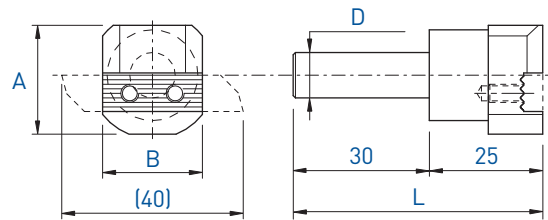

A x B	L	D	Art. N°
24 x 22	55	10	760/750-D10

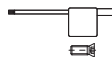

Chaque support est livré avec vis et clé.
 Jeder Halter wird mit Spannschraube(n) und Schlüssel geliefert.
 Screw(s) and key are included with each tool holder.

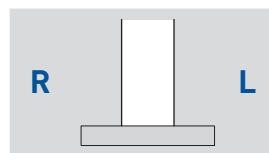
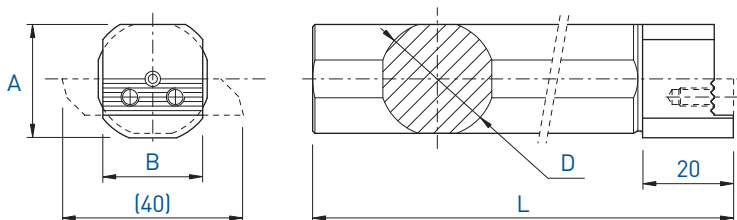

A x B	L	D	Art. N°
25 x 22	160	16	760/750-D16
25 x 22	160	19.05	760/750-D19.05
25 x 22	110	19.05	760/750-D19.05-S
25 x 22	160	20	760/750-D20
25 x 22	110	22	760/750-D22
25 x 22	200	25	760/750-D25
25 x 22	200	25.4	760/750-D25.4
25 x 22	125	25.4	760/750-D25.4-S

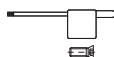

Chaque support est livré avec vis et clé.
 Jeder Halter wird mit Spannschraube(n) und Schlüssel geliefert.
 Screw(s) and key are included with each tool holder.

Porte-outils

Halter

Holders

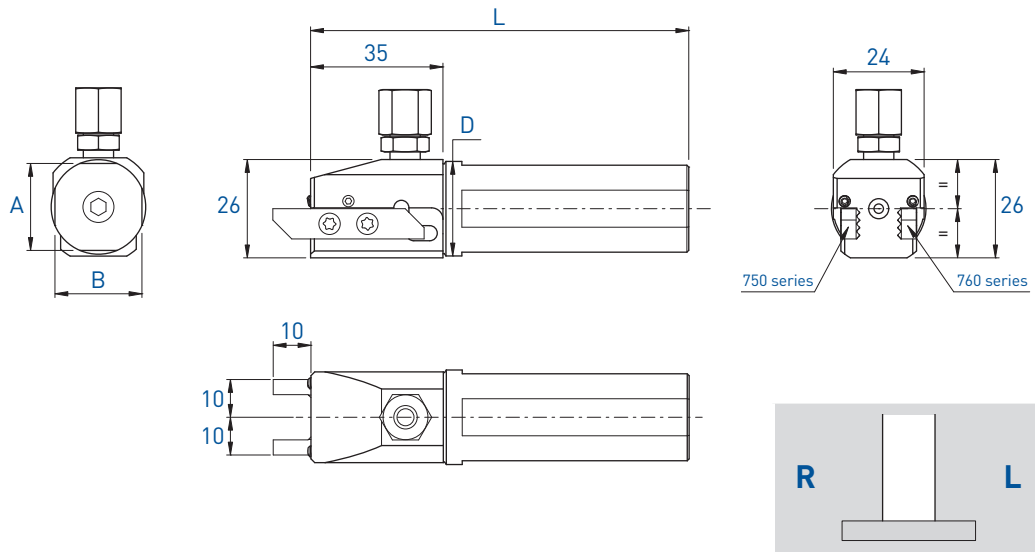

760 / 750-AX

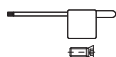

A x B	L	D	Art. N°
23 x 23	100	25	760/750-AX-D25-JET
23 x 23	100	25.4	760/750-AX-D25.4-JET

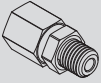

Chaque support est livré avec vis et clé.
 Jeder Halter wird mit Spannschraube(n)
 und Schlüssel geliefert.
 Screw(s) and key are included with each
 tool holder.

Pièces de rechange Ersatzteile Spare parts			Buse Düse Nozzle 
	Art. N°	Art. N°	Art. N°
760/750-AX	J-M8X1-D6	JB-M8X1	JJ-M3X6-D1.5

Porte-outils

Halter

Holders

770 / 780

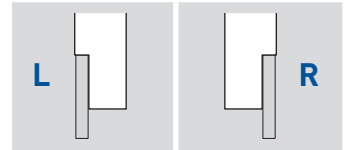
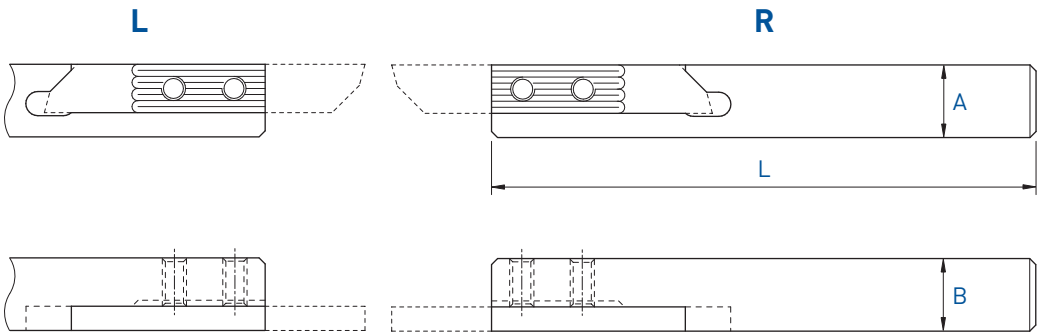

A x B	L	Serrage Spannsystem Clamping	Art. N°	Art. N°
10 x 10	115	A	770-10	780-10
12 x 12	130	A	770-12	780-12
12 x 12	90	A	770-12-90	780-12-90
12.7 x 12.7	130	A	770-12.7	780-12.7
14 x 14	130	A	770-14	780-14
16 x 16	130	A	770-16	780-16
16 x 16	75	A	770-16-75	780-16-75
20 x 20	120	A	770-20	780-20
25 x 25	140	A	770-25	780-25



Chaque support est livré avec vis et clé.
 Jeder Halter wird mit Spannschraube(n) und Schlüssel geliefert.
 Screw(s) and key are included with each tool holder.

Porte-outils avec arrosage intégré
 Halter mit integrierter Kühlmittelzufuhr
 Holders with integrated coolant supply

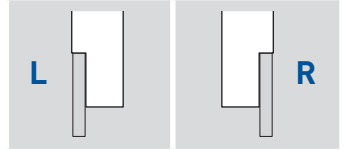
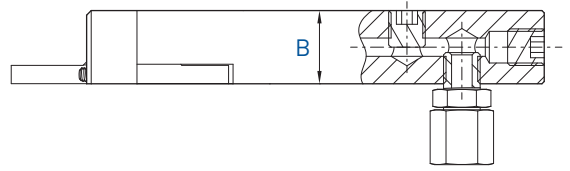
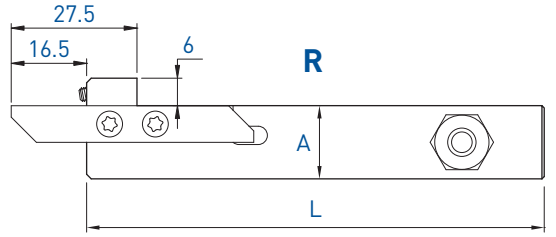
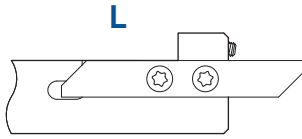

770-JET / 780-JET

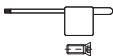

A x B	L	Serrage Spannsystem Clamping	Art. N°	Art. N°
16 x 16	100	A	770-16-JET	780-16-JET

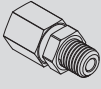

Chaque support est livré avec vis et clé.
 Jeder Halter wird mit Spannschraube(n)
 und Schlüssel geliefert.
 Screw(s) and key are included with each
 tool holder.

Pièces de rechange Ersatzteile Spare parts			Buse Düse Nozzle
	Art. N°	Art. N°	Art. N°
770-JET / 780-JET	J-M8X1-D6	JB-M8X1	JJ-M3X6-D1.5

Porte-outils
Halter
Holders

Coupe déportée
Versetzttes Schneiden
Cut off line

770RC

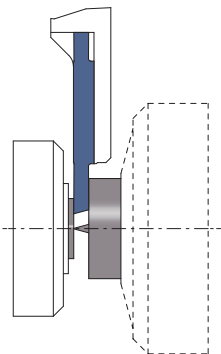
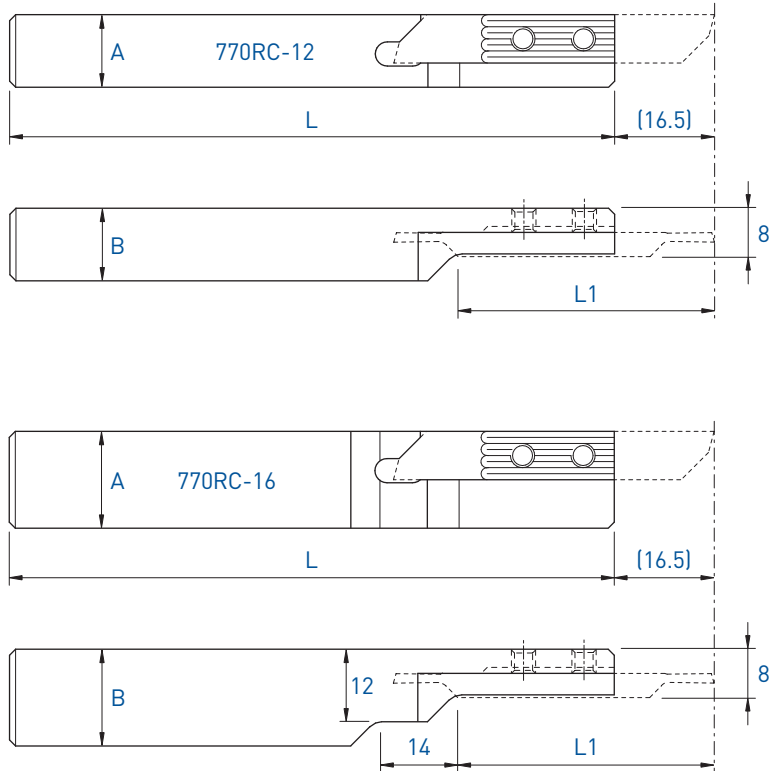

Utiliser des plaquettes type 771R
WSP Typ 771R verwenden
Use inserts type 771R

Voir pages 1.138 - 1.141
Siehe Seiten 1.138 - 1.141
See pages 1.138 - 1.141

 L (R) Coupe à droite déportée Versetztes Rechtsschneiden Right cut off line				
A x B	L	L1	Serrage Spannsystem Clamping	Art. N°
12 x 12	130	42	A	770RC-12
16 x 16	130	42	A	770RC-16



Chaque support est livré avec vis et clé.
Jeder Halter wird mit Spannschraube(n) und Schlüssel geliefert.
Screw(s) and key are included with each tool holder.

Porte-outils

Halter

Holders

7050 / 7060

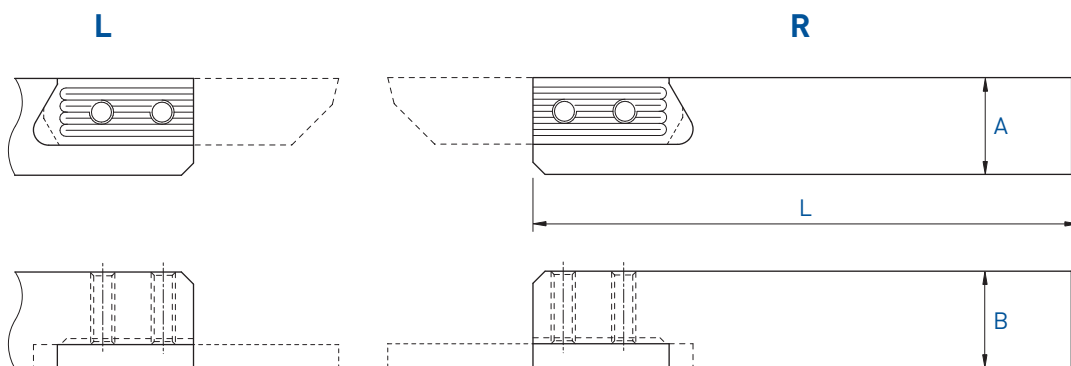

A x B	L	Serrage Spannsystem Clamping		
			Art. N°	Art. N°
16 x 16	130	A	7050-16	7060-16
16 x 16	75	A	7050-16-75	7060-16-75
20 x 20	120	A	7050-20	7060-20
25 x 25	140	A	7050-25	7060-25

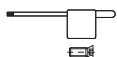

Chaque support est livré avec vis et clé.
Jeder Halter wird mit Spannschraube(n) und Schlüssel geliefert.
Screw(s) and key are included with each tool holder.

■ = disponible / verfügbar / available

□ = selon disponibilité du stock / jenach Lagerverfügbarkeit / depending on stock availability

Porte-outils

Halter

Holder

W750 / W760

L

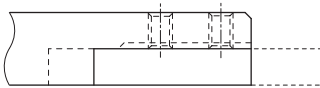
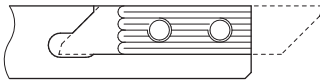

R

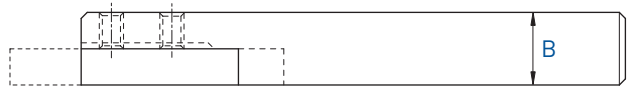
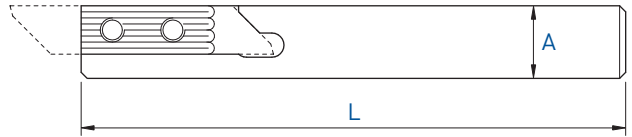

L

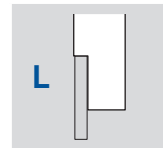

R

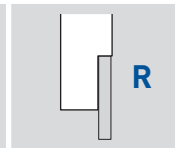

A x B	L	Serrage Spannsystem Clamping	Art. N°	Art. N°
12 x 12	130	A	W750-12	W760-12
16 x 16	130	A	W750-16	W760-16
20 x 20	120	A	W750-20	W760-20



Chaque support est livré avec vis et clé.
Jeder Halter wird mit Spannschraube(n) und Schlüssel geliefert.
Screw(s) and key are included with each tool holder.

■ = disponible / verfügbar / available

□ = selon disponibilité du stock / jenach Lagerverfügbarkeit / depending on stock availability

TOP-LINE

Porte-outils avec arrosage intégré
 Halter mit integrierter Kühlmittelzufuhr
 Holders with integrated coolant supply

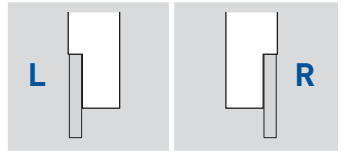
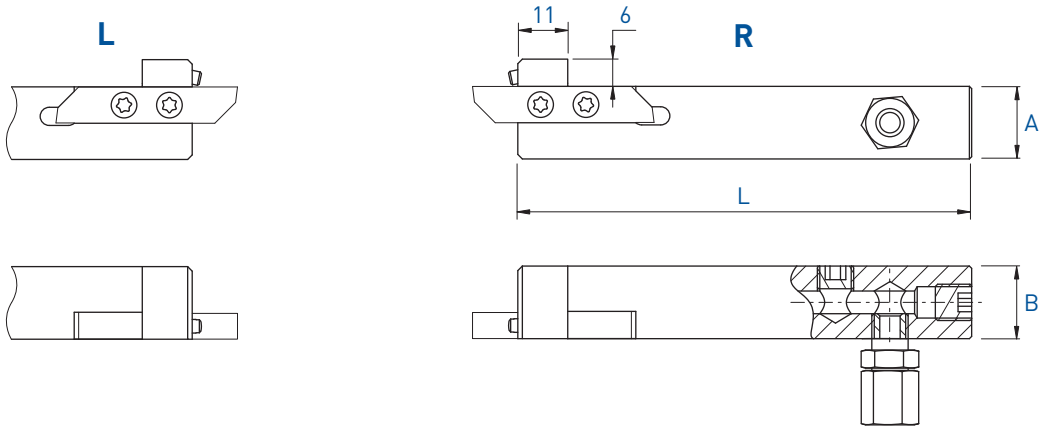

W750-JET / W760-JET

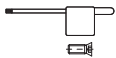

A x B	L	Serrage Spannsystem Clamping	Art. N°	Art. N°
16 x 16	100	A	W750-16-JET	W760-16-JET
20 x 20	100	A	W750-20-JET	W760-20-JET

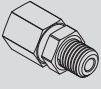

Chaque support est livré avec vis et clé.
 Jeder Halter wird mit Spannschraube(n)
 und Schlüssel geliefert.
 Screw(s) and key are included with each
 tool holder.

Pièces de rechange Ersatzteile Spare parts			Buse Düse Nozzle 
	Art. N°	Art. N°	Art. N°
W750-JET / W760-JET	J-M8X1-D6	JB-M8X1	JJ-M3X6-D1.5