

Plaquettes ébauches

WSP-Rohlinge

Blank inserts

711-EP / 721-EP

L

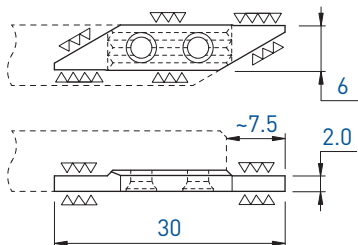

R

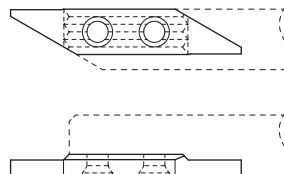

L		R			
Art. N°	TiAlN TiN N (µk20)	HTA HTiN HN (µk10)	Art. N°	TiAlN TiN N (µk20)	HTA HTiN HN (µk10)
711-EP	■ ■ ■	■ □ ■	721-EP	■ □ ■	□ □ ■

Plaquettes ébauches  
WSP-Rohlinge  
Blank inserts

731-E / 741-E  
731-EP / 741-EP

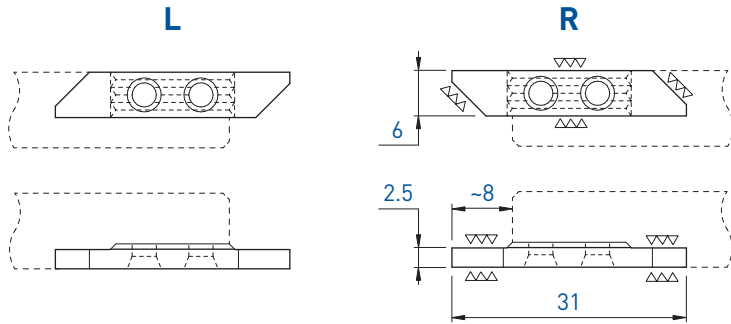
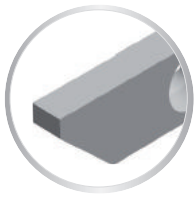

L			R		
Art. N°	N (µk20)	HN (µk10)	Art. N°	N (µk20)	HN (µk10)
731-E	■	■	741-E	■	■

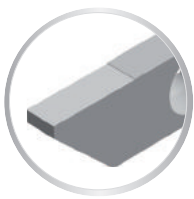

Face de coupe polie  
Polierte Schneidfläche  
Polished cutting face

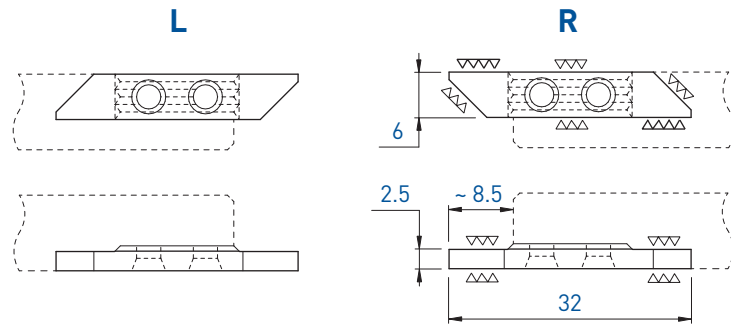

L						R							
Art. N°	TiAlN	TiN	N (µk20)	HTA	HTiN	HN (µk10)	Art. N°	TiAlN	TiN	N (µk20)	HTA	HTiN	HN (µk10)
731-EP	■	■	■	■	■	■	741-EP	■	■	■	■	□	■

7XX-XX-B



Sur demande pour serrage type B,  
voir page 1.03  
Wahlweise mit B-Spannsystem,  
siehe Seite 1.03  
On request for B clamping system,  
see page 1.03

■ = disponible / verfügbar / available  
□ = selon disponibilité du stock / jenach Lagerverfügbarkeit / depending on stock availability

Plaquettes ébauches  
WSP-Rohlinge  
Blank inserts

751-E / 761-E  
751-EP / 761-EP

L

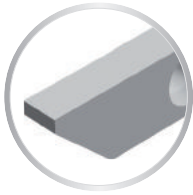
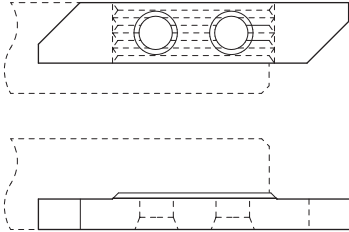

7XX-XX-B



Sur demande pour serrage type B, voir page 1.03  
Wahlweise mit B-Spannsystem, siehe Seite 1.03  
On request for B clamping system, see page 1.03

R

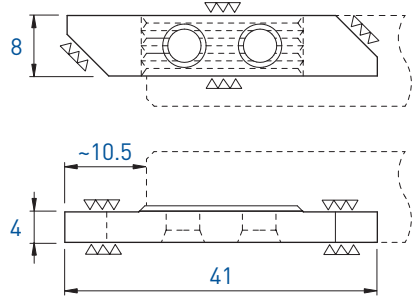

L		R	
Art. N°	N (µk20) HN (µk10)	Art. N°	N (µk20) HN (µk10)
751-E	■ ■	761-E	■ ■

L

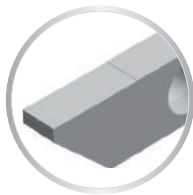
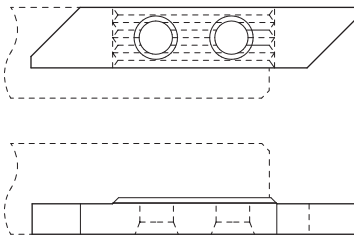

Face de coupe polie  
Polierte Schneidfläche  
Polished cutting face

R

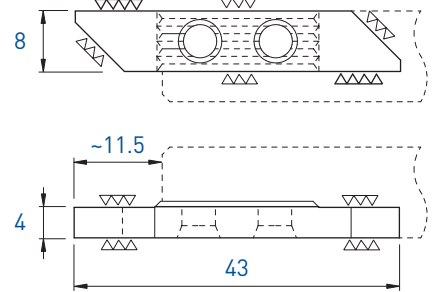

L					R				
Art. N°	TiAlN	TiN	N (µk20)	HTA HTiN HN (µk10)	Art. N°	TiAlN	TiN	N (µk20)	HTA HTiN HN (µk10)
751-EP	■	■	■	□ □ ■	761-EP	■	■	■	■ □ ■

**L**

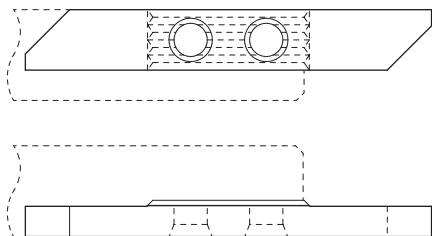

**R**

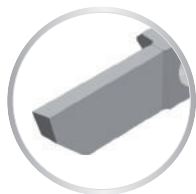
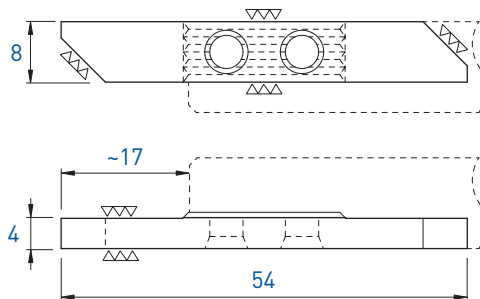

<b>L</b>		<b>R</b>	
Art. N°	N (µk20)	Art. N°	N (µk20)
771-E	■	781-E	■

L

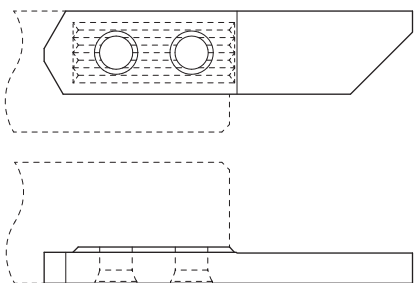

R

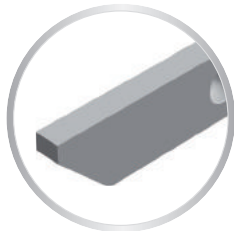
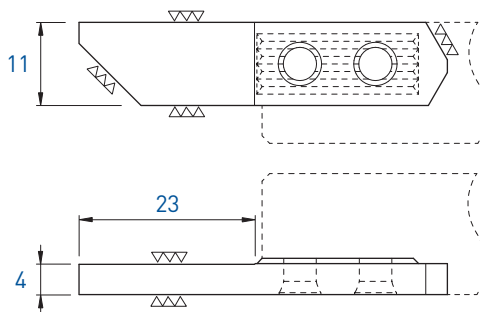

L		R	
Art. N°	N (µk20)	Art. N°	N (µk20)
7051-E	■	7061-E	■

Plaquettes ébauches  
WSP-Rohlinge  
Blank inserts

W751-E5 / W761-E5  
W751-EP5 / W761-EP5

L

R

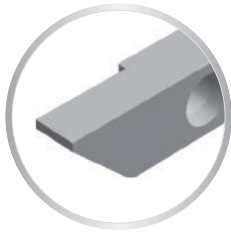
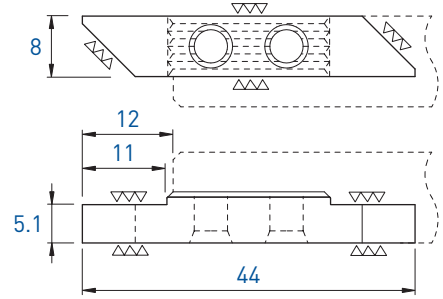
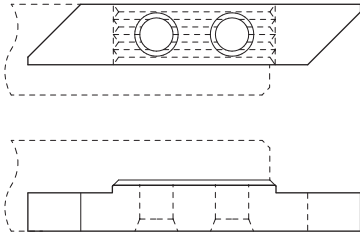

L		R	
Art. N°	N (µk20)	Art. N°	N (µk20)
W751-E5	■	W761-E5	■

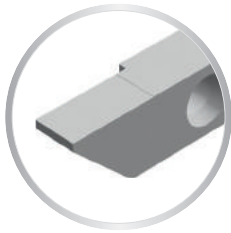
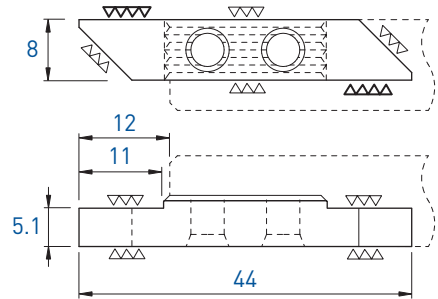
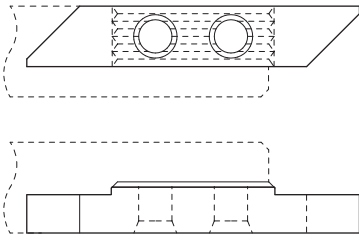

L		R	
Art. N°	N (µk20)	Art. N°	N (µk20)
W751-EP5	■	W761-EP5	■

# TOP-LINE

Plaquettes ébauches  
WSP-Rohlinge  
Blank inserts

W751-E6 / W761-E6  
W751-EP6 / W761-EP6

L

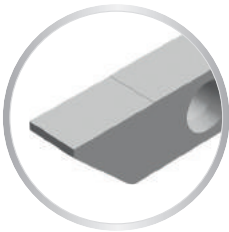
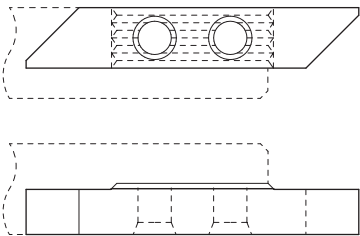
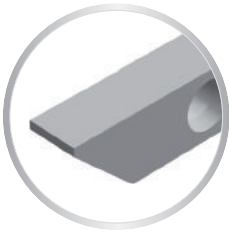
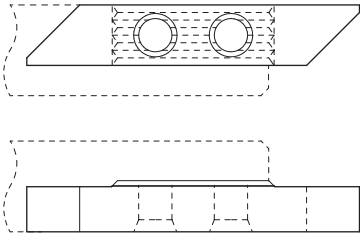

R

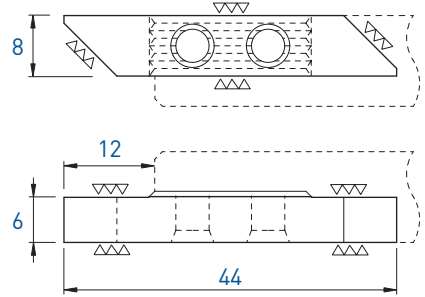

L		R	
Art. N°	N (μk20)	Art. N°	N (μk20)
W751-E6	■	W761-E6	■

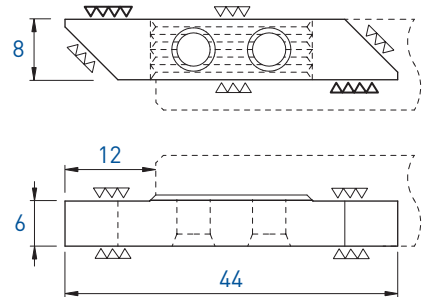

L		R	
Art. N°	N (μk20)	Art. N°	N (μk20)
W751-EP6	■	W761-EP6	■