

<p>Tronçonnage</p> <p>Abstechen</p> <p>Parting off</p>	<p>Coupe déportée</p> <p>Versetztes Schneiden</p> <p>Cut off line</p>	<p>7061L / 7051R</p>
---	--	-----------------------------

Cut L

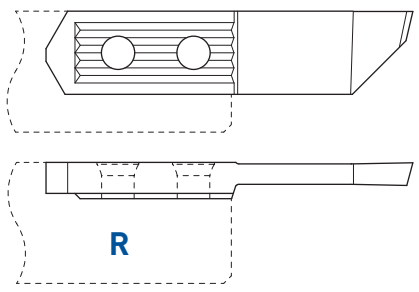

Cut R

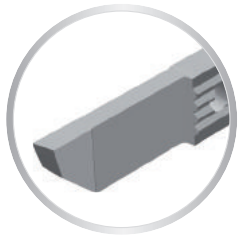
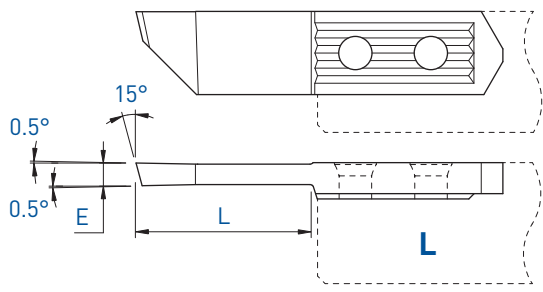

<p>R (L)</p> <p>Coupe à gauche déportée Versetztes Linksschneiden Left cut off line</p>	<p>L (R)</p> <p>Coupe à droite déportée Versetztes Rechtsschneiden Right cut off line</p>
--	--

E	L	Art. N°	TiAlN	TiN	N (µk20)	Art. N°	TiAlN	TiN	N (µk20)
2.5	22	-				7051R-2.5	■	■	■
3.0	22	7061L-3.0	■	■	■	7051R-3.0	■	■	■
3.5	22	-				7051R-3.5	■	■	■

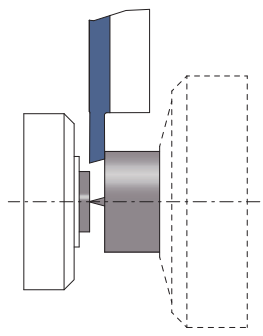

Tronçonnage
Abstechen
Parting off

Coupe déportée
Versetztes Schneiden
Cut off line

7061LXF / 7051RXF

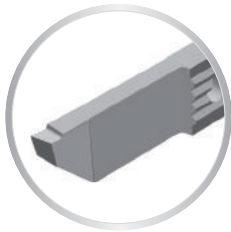
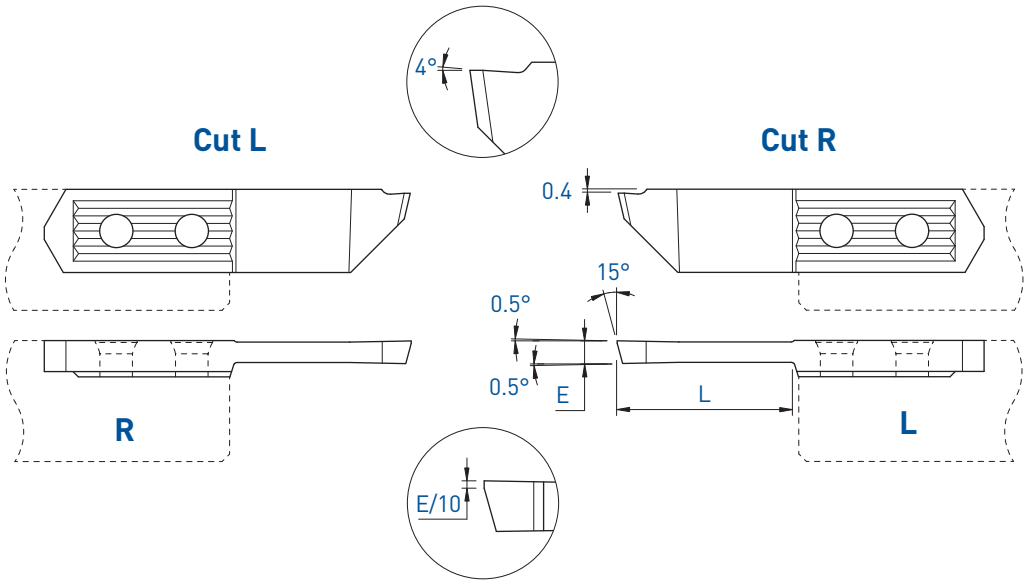

R (L)	L (R)
Coupe à gauche déportée Versetztes Linksschneiden Left cut off line	Coupe à droite déportée Versetztes Rechtsschneiden Right cut off line

E	L	Art. N°	TiAIN	TiN	N (µk20)	Art. N°	TiAIN	TiN	N (µk20)
3.0	22	7061LXF-3.0	■	■	■	7051RXF-3.0	■	■	■

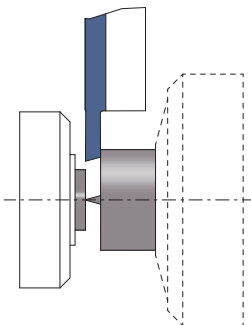

■ = disponible / verfügbar / available
□ = selon disponibilité du stock / jenach Lagerverfügbarkeit / depending on stock availability