

A x B	L	Serrage Spannsystem Clamping	Art. N°	Art. N°
6 x 6	115	A	<b>710-6</b>	-
7 x 7	115	A	<b>710-7</b>	<b>720-7</b>
8 x 8	115	A	<b>710-8</b>	<b>720-8</b>
8 x 8	140	A	<b>710-8-140</b>	-
10 x 10	115	A	<b>710-10</b>	<b>720-10</b>
12 x 12	130	A	<b>710-12</b>	<b>720-12</b>



Chaque support est livré avec vis et clé.  
 Jeder Halter wird mit Spannschraube(n) und Schlüssel geliefert.  
 Screw(s) and key are included with each tool holder.

Porte-outils en métal lourd anti-vibratoire  
 Schwingungsdämpfende Schwermetallhalter  
 Low vibration heavy metal holders

710-NOVIBRA

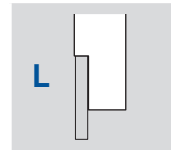
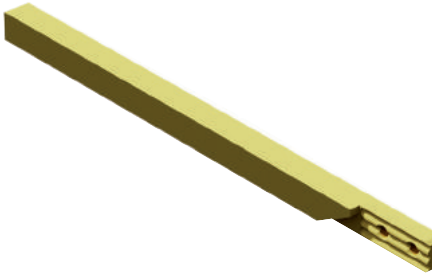
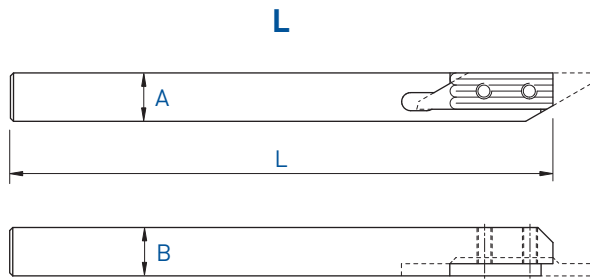

A x B	L	Serrage Spannsystem Clamping	Art. N°
6 x 6	115	A	710-6-NOVIBRA
7 x 7	115	A	710-7-NOVIBRA
8 x 8	115	A	710-8-NOVIBRA



Chaque support est livré avec vis et clé.  
 Jeder Halter wird mit Spannschraube(n) und Schlüssel geliefert.  
 Screw(s) and key are included with each tool holder.

L

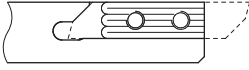

R

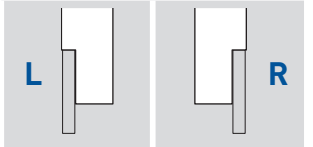
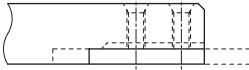
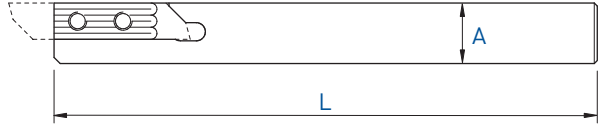

Serrage standard A  
Standard Spannsystem A  
Standard clamping system A

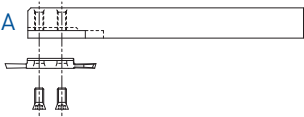

Serrage B  
Spannsystem B  
Clamping system B

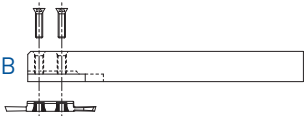

A x B	L	Serrage Spannsystem Clamping	Art. N°	Art. N°
7 x 7	115	A	730-7	740-7
8 x 8	115	A + B	730-8	740-8
8 x 8	140	A + B	730-8-140	-
10 x 10	115	A + B	730-10	740-10
10 x 10	50	A + B	730-10-50	740-10-50
12 x 12	130	A + B	730-12	740-12
12 x 12	90	A + B	730-12-90	740-12-90
12.7 x 12.7	130	A + B	730-12.7	740-12.7
16 x 16	130	A + B	730-16	740-16
16 x 16	75	A + B	730-16-75	740-16-75
20 x 20	120	A + B	730-20	740-20

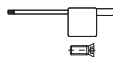

Chaque support est livré avec vis et clé.  
Jeder Halter wird mit Spannschraube(n) und Schlüssel geliefert.  
Screw(s) and key are included with each tool holder.

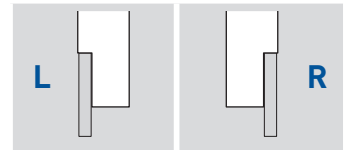
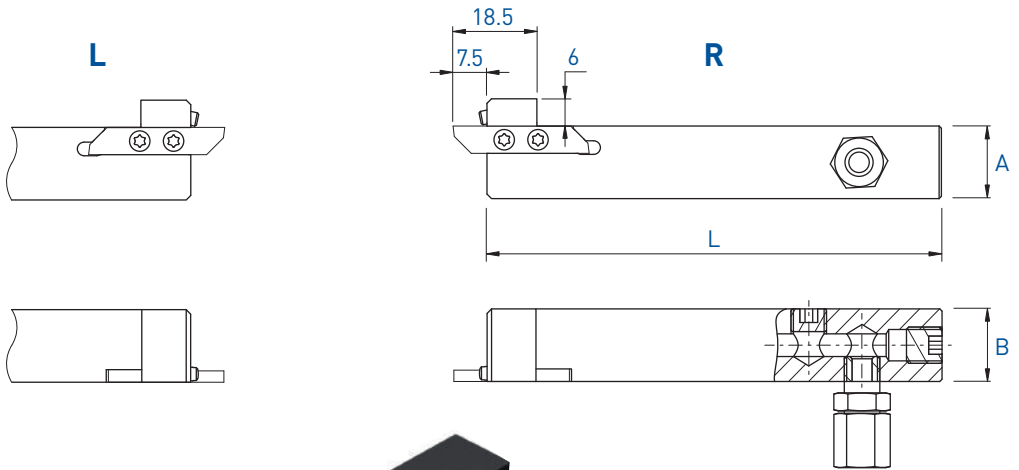

Porte-outils avec arrosage intégré  
 Halter mit integrierter Kühlmittelzufuhr  
 Holders with integrated coolant supply

730-JET / 740-JET



A x B	L	Serrage Spannsystem Clamping	Art. N°	Art. N°
8 x 10	100	A + B	-	740-0810-JET
10 x 12	100	A + B	730-1012-JET	740-1012-JET
10 x 12	80	A + B	-	740-1012-80-JET <b>new</b>
12 x 12	100	A + B	730-12-JET	740-12-JET
12.7 x 12.7	100	A + B	730-12.7-JET	740-12.7-JET
16 x 16	100	A + B	730-16-JET	740-16-JET
20 x 20	100	A + B	730-20-JET	740-20-JET

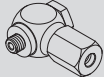

Pièces de rechange Ersatzteile Spare parts			Buse Düse Nozzle 	Option 
	Art. N°	Art. N°	Art. N°	Art. N°
740-0810-JET	J-M5-D5	JB-M5	-	JC-M5-D5
730-JET / 740-JET	J-M8X1-D6	JB-M8X1	JJ-M3X6-D1.5	-

Chaque support est livré avec vis et clé.  
 Jeder Halter wird mit Spannschraube(n) und Schlüssel geliefert.  
 Screw(s) and key are included with each tool holder.



R

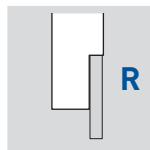
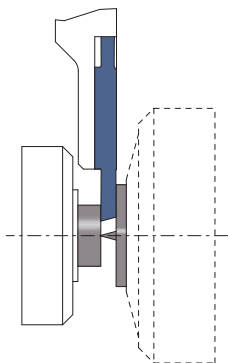
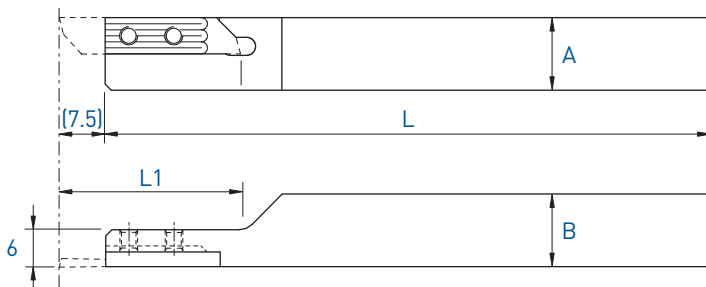

A x B	L	L1	Serrage Spannsystem Clamping	Art. N°
8 x 8	115	24	A	<b>740-C-8</b>
10 x 10	115	24	A	<b>740-C-10</b>
12 x 12	130	30	A	<b>740-C-12</b>
16 x 16	130	40	A	<b>740-C-16</b>

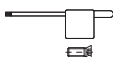

Chaque support est livré avec vis et clé.  
Jeder Halter wird mit Spannschraube(n) und Schlüssel geliefert.  
Screw(s) and key are included with each tool holder.

Porte-outils

Halter

Holders

Coupe à droite déportée

Versetztes Rechtsschneiden

Right cut off line

730RC

Utiliser des plaquettes type 731R  
 WSP Typ 731R verwenden  
 Use inserts type 731R

Voir pages 1.39 - 1.45  
 Siehe Seiten 1.39 - 1.45  
 See pages 1.39 - 1.45

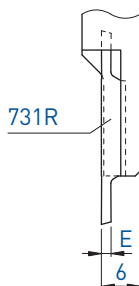
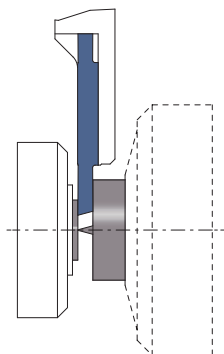
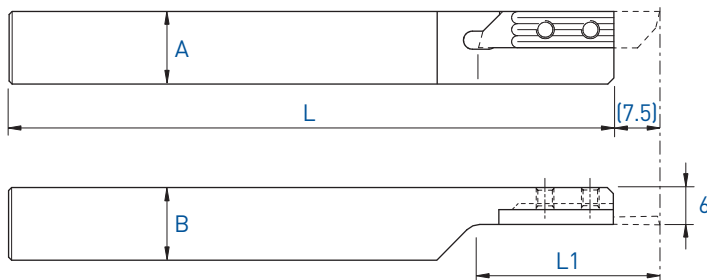
**L (R)**

Coupe à droite déportée  
 Versetztes Rechtsschneiden  
 Right cut off line

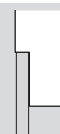

A x B	L	L1	Art. N°
8 x 8	115	24	<b>730RC-8</b>
10 x 10	115	24	<b>730RC-10</b>
12 x 12	130	30	<b>730RC-12</b>
16 x 16	130	40	<b>730RC-16</b>

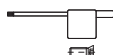

Chaque support est livré avec vis et clé.  
 Jeder Halter wird mit Spannschraube(n) und Schlüssel geliefert.  
 Screw(s) and key are included with each tool holder.

Porte-outils en métal lourd anti-vibratoire  
 Schwingungsdämpfende Schwermetallhalter  
 Low vibration heavy metal holders

**730-NOVIBRA**  
**740-NOVIBRA**

**L**

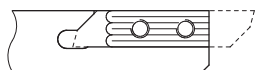

**R**

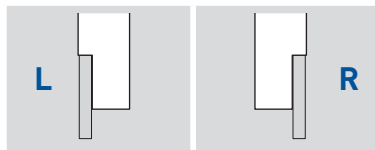
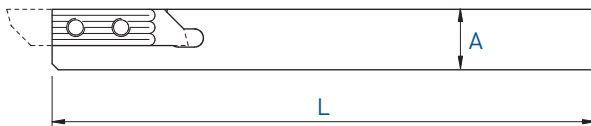

A x B	L	Serrage Spannsystem Clamping	Art. N°	Art. N°
7 x 7	115	A	<b>730-7-NOVIBRA</b>	<b>740-7-NOVIBRA</b>
8 x 8	115	A + B	<b>730-8-NOVIBRA</b>	<b>740-8-NOVIBRA</b>
8 x 8	80	A + B	-	<b>740-8-80-NOVIBRA</b>
10 x 10	115	A + B	-	<b>740-10-NOVIBRA</b>
12 x 12	130	A + B	-	<b>740-12-NOVIBRA</b>

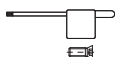

Chaque support est livré avec vis et clé.  
 Jeder Halter wird mit Spannschraube(n) und Schlüssel geliefert.  
 Screw(s) and key are included with each tool holder.

Porte-outils

Halter

Holder

740 / 730-D

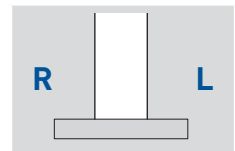
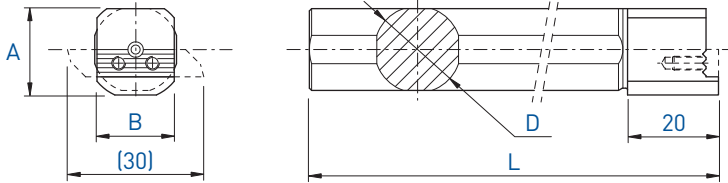

A x B	L	D	Art. N°
19 x 17	160	16	740/730-D16
19 x 17	160	19.05	740/730-D19.05
19 x 17	110	19.05	740/730-D19.05-S
19.5 x 17	160	20	740/730-D20
20 x 17	110	22	740/730-D22
22 x 17	200	25	740/730-D25
22 x 17	200	25.4	740/730-D25.4

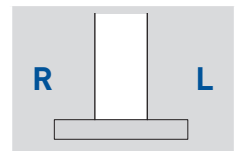
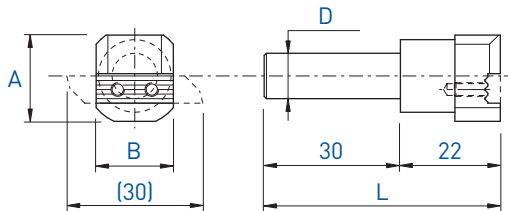

A x B	L	D	Art. N°
19 x 17	52	10	740/730-D10

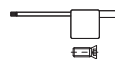

Chaque support est livré avec vis et clé.  
 Jeder Halter wird mit Spannschraube(n) und Schlüssel geliefert.  
 Screw(s) and key are included with each tool holder.



L

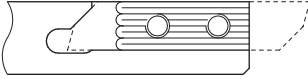

R

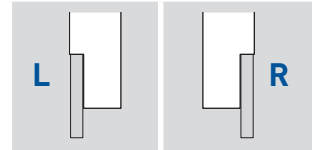
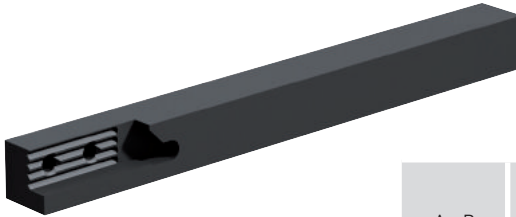
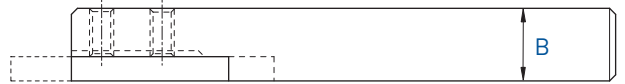
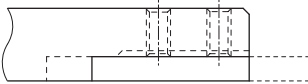
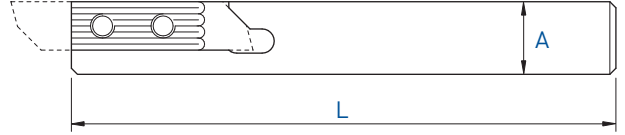

Serrage standard A  
Standard Spannsystem A  
Standard clamping system A

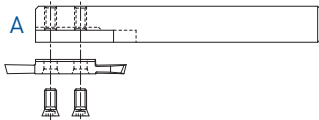

A x B	L	Serrage Spannsystem Clamping	Art. N°	Art. N°
10 x 10	115	A	750-10	760-10
10 x 10	115	A + B	750-10-AB	760-10-AB
10 x 10	50	A	750-10-50	760-10-50
12 x 12	130	A	750-12	760-12
12 x 12	130	A + B	750-12-AB	760-12-AB
12 x 12	90	A	750-12-90	760-12-90
12 x 12	90	A + B	750-12-90-AB	760-12-90-AB
12.7 x 12.7	130	A + B	750-12.7	760-12.7
14 x 14	130	A + B	750-14	760-14
16 x 16	130	A + B	750-16	760-16
16 x 16	75	A + B	750-16-75	760-16-75
20 x 20	120	A + B	750-20	760-20
25 x 25	140	A	760/750-25	

Serrage A + B  
Spannsystem A + B  
Clamping system A + B

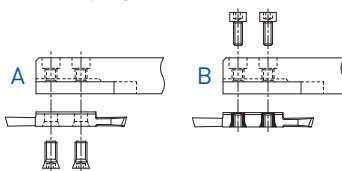

760/750-25  
R + L



Chaque support est livré avec vis et clé.  
Jeder Halter wird mit Spannschraube(n) und Schlüssel geliefert.  
Screw(s) and key are included with each tool holder.

Porte-outils avec arrosage intégré  
 Halter mit integrierter Kühlmittelzufuhr  
 Holders with integrated coolant supply

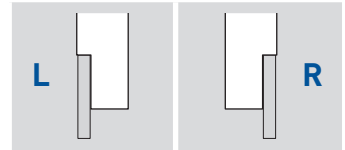
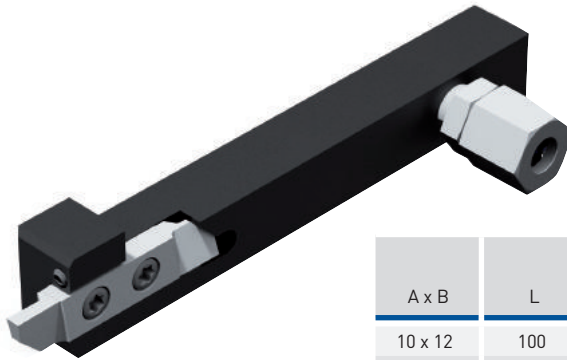
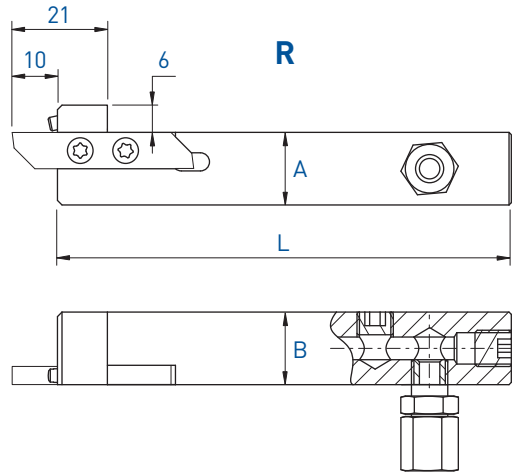
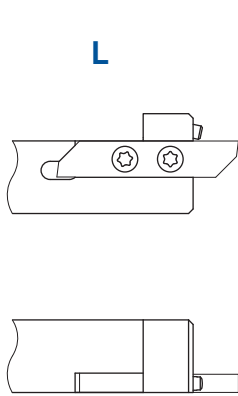

750-JET / 760-JET



A x B	L	Serrage Spannsystem Clamping	Art. N°	Art. N°
10 x 12	100	A + B	750-1012-JET	760-1012-JET
10 x 12	80	A + B	-	760-1012-80-JET <b>new</b>
12 x 12	100	A + B	750-12-JET	760-12-JET
12.7 x 12.7	100	A + B	750-12.7-JET	760-12.7-JET
16 x 16	100	A + B	750-16-JET	760-16-JET
20 x 20	100	A + B	750-20-JET	760-20-JET

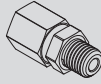

Chaque support est livré avec vis et clé.  
 Jeder Halter wird mit Spannschraube(n)  
 und Schlüssel geliefert.  
 Screw(s) and key are included with each  
 tool holder.

Pièces de rechange Ersatzteile Spare parts			Buse Düse Nozzle 
	Art. N°	Art. N°	Art. N°
750-JET / 760-JET	J-M8X1-D6	JB-M8X1	JJ-M3X6-D1.5

**Porte-outils**  
**Halter**  
**Holder**

**Coupe à droite déportée**  
**Versetztes Rechtsschneiden**  
**Right cut off line**

**750RC**

Utiliser des plaquettes type 751R  
 WSP Typ 751R verwenden  
 Use inserts type 751R

Voir pages 1.88 - 1.99  
 Siehe Seiten 1.88 - 1.99  
 See pages 1.88 - 1.99

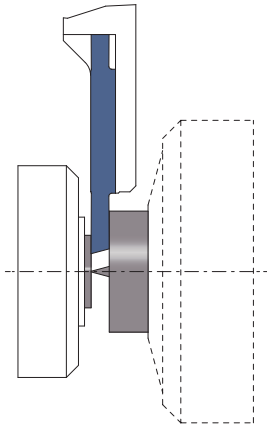
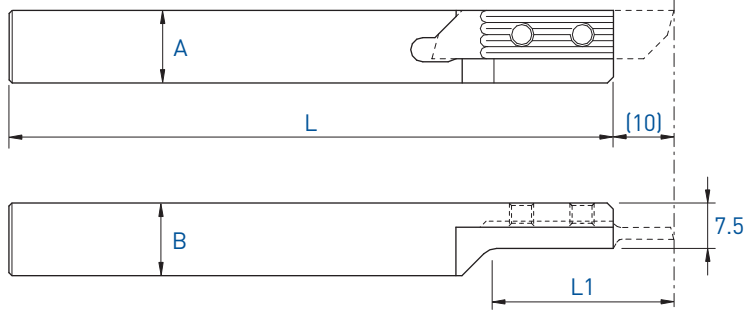

<b>L (R)</b>			
Coupe à droite déportée Versetztes Rechtsschneiden Right cut off line			
A x B	L	L1	Art. N°
12 x 12	130	30	<b>750RC-12</b>
16 x 16	130	40	<b>750RC-16</b>

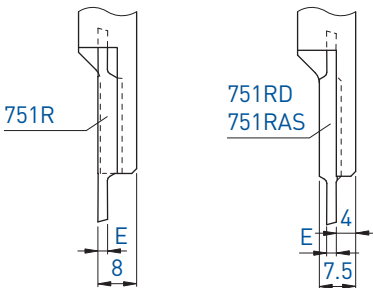

(p. 1.98 - 1.99)



Chaque support est livré avec vis et clé.  
 Jeder Halter wird mit Spanschraube(n) und Schlüssel geliefert.  
 Screw(s) and key are included with each tool holder.

Porte-outils

Halter

Holder

Coupe à gauche déportée

Versetztes Linksschneiden

Left cut off line

760LC

Utiliser des plaquettes type 761L  
WSP Typ 761L verwenden  
Use insets type 761L

Voir pages 1.88 - 1.94 + 1.98  
Siehe Seiten 1.88 - 1.94 + 1.98  
See pages 1.88 - 1.94 + 1.98

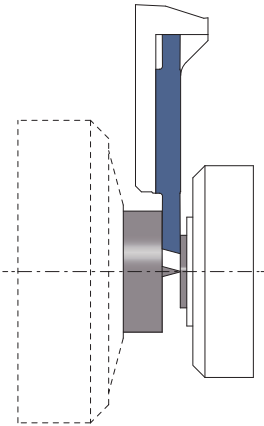
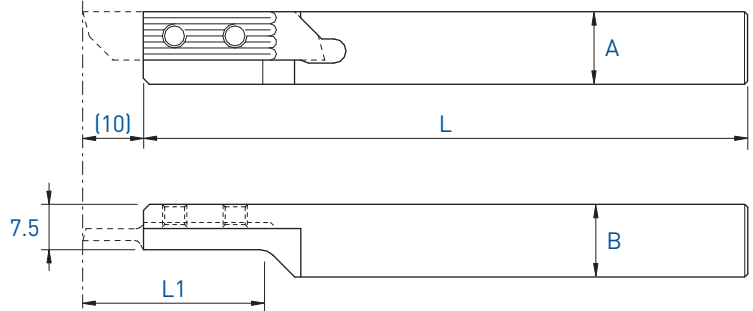

R (L)

Coupe à gauche déportée  
Versetztes Linksschneiden  
Left cut off line

A x B	L	L1	Art. N°
16 x 16	130	40	760LC-16

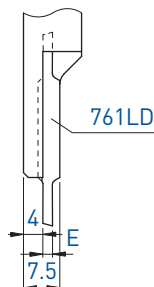
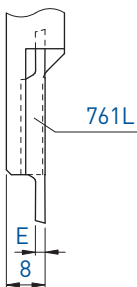

(p. 1.98)



Chaque support est livré avec vis et clé.  
Jeder Halter wird mit Spannschraube(n) und Schlüssel geliefert.  
Screw(s) and key are included with each tool holder.

R

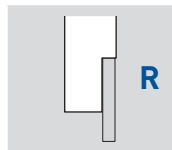
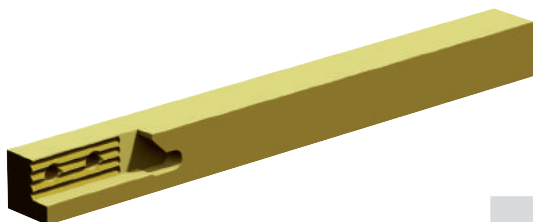
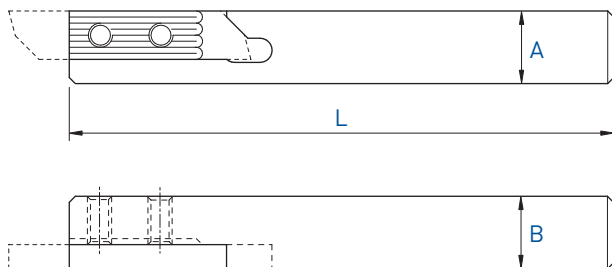

A x B	L	Serrage Spannsystem Clamping	Art. N°
10 x 10	115	A	<b>760-10-NOVIBRA</b>
12 x 12	130	A	<b>760-12-NOVIBRA</b>



Chaque support est livré avec vis et clé.  
 Jeder Halter wird mit Spannschraube(n) und Schlüssel geliefert.  
 Screw(s) and key are included with each tool holder.

Porte-outils

Halter

Holders

760 / 750-D10

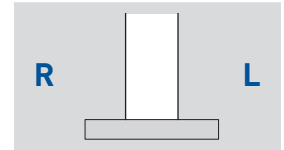
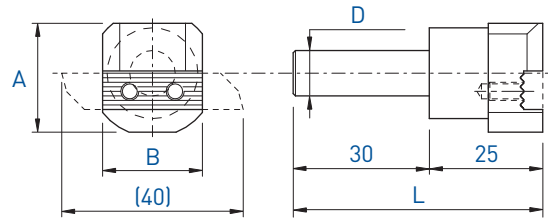

A x B	L	D	Art. N°
24 x 22	55	10	760/750-D10

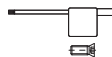

Chaque support est livré avec vis et clé.  
 Jeder Halter wird mit Spannschraube(n) und Schlüssel geliefert.  
 Screw(s) and key are included with each tool holder.

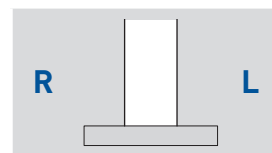
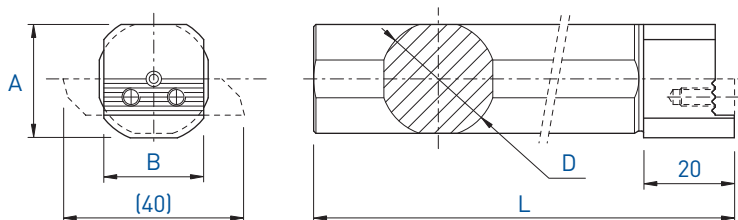

A x B	L	D	Art. N°
25 x 22	160	16	<b>760/750-D16</b>
25 x 22	160	19.05	<b>760/750-D19.05</b>
25 x 22	110	19.05	<b>760/750-D19.05-S</b>
25 x 22	160	20	<b>760/750-D20</b>
25 x 22	110	22	<b>760/750-D22</b>
25 x 22	200	25	<b>760/750-D25</b>
25 x 22	200	25.4	<b>760/750-D25.4</b>
25 x 22	125	25.4	<b>760/750-D25.4-S</b>



Chaque support est livré avec vis et clé.  
 Jeder Halter wird mit Spannschraube(n) und Schlüssel geliefert.  
 Screw(s) and key are included with each tool holder.

Porte-outils  
 Halter  
 Holders

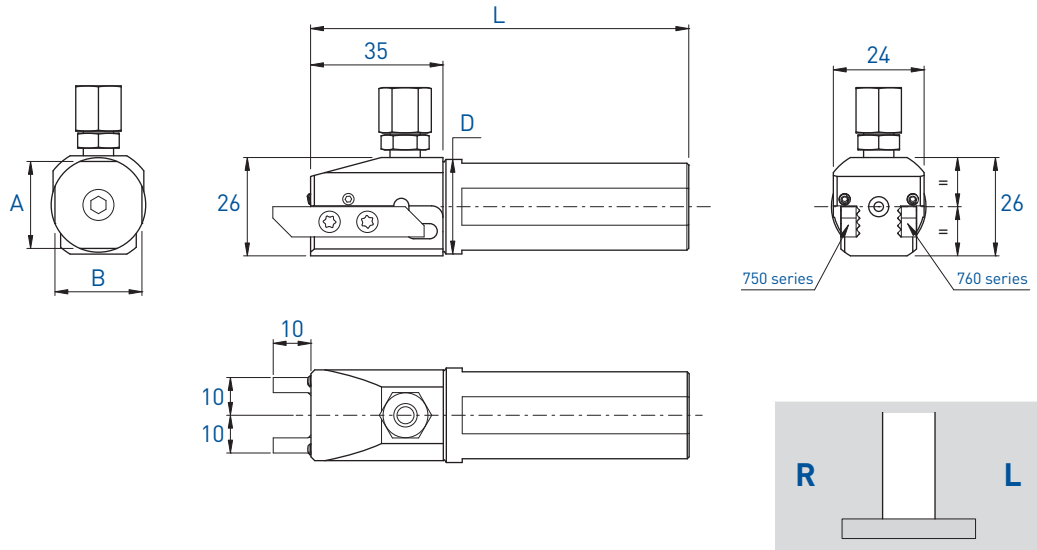

760 / 750-AX

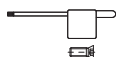

A x B	L	D	Art. N°
23 x 23	100	25	760/750-AX-D25-JET
23 x 23	100	25.4	760/750-AX-D25.4-JET

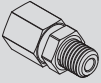

Chaque support est livré avec vis et clé.  
 Jeder Halter wird mit Spannschraube(n)  
 und Schlüssel geliefert.  
 Screw(s) and key are included with each  
 tool holder.

Pièces de rechange Ersatzteile Spare parts			Buse Düse Nozzle 
	Art. N°	Art. N°	Art. N°
760/750-AX	J-M8X1-D6	JB-M8X1	JJ-M3X6-D1.5



Porte-outils

Halter

Holders

770 / 780

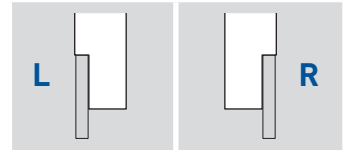
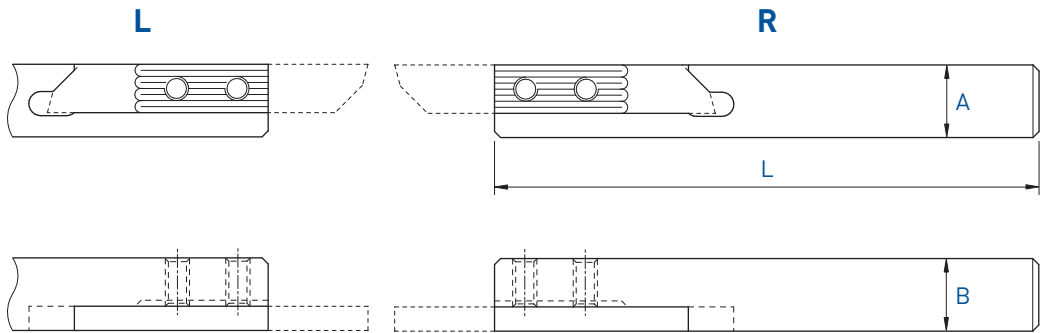

A x B	L	Serrage Spannsystem Clamping	Art. N°	Art. N°
10 x 10	115	A	<b>770-10</b>	<b>780-10</b>
12 x 12	130	A	<b>770-12</b>	<b>780-12</b>
12 x 12	90	A	<b>770-12-90</b>	<b>780-12-90</b>
12.7 x 12.7	130	A	<b>770-12.7</b>	<b>780-12.7</b>
14 x 14	130	A	<b>770-14</b>	<b>780-14</b>
16 x 16	130	A	<b>770-16</b>	<b>780-16</b>
16 x 16	75	A	<b>770-16-75</b>	<b>780-16-75</b>
20 x 20	120	A	<b>770-20</b>	<b>780-20</b>
25 x 25	140	A	<b>770-25</b>	<b>780-25</b>



Chaque support est livré avec vis et clé.  
 Jeder Halter wird mit Spannschraube(n) und Schlüssel geliefert.  
 Screw(s) and key are included with each tool holder.

Porte-outils avec arrosage intégré  
 Halter mit integrierter Kühlmittelzufuhr  
 Holders with integrated coolant supply

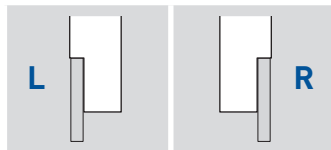
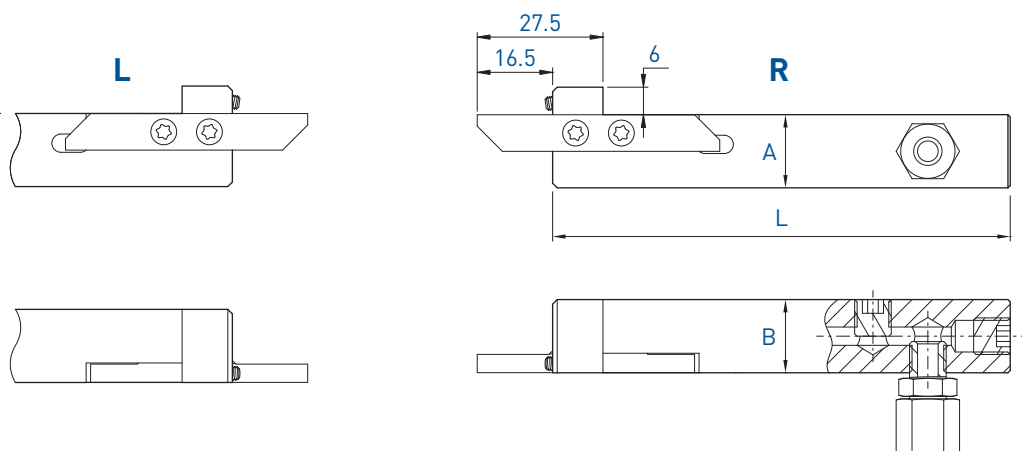

## 770-JET / 780-JET

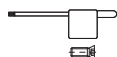

A x B	L	Serrage Spannsystem Clamping	Art. N°	Art. N°
16 x 16	100	A	770-16-JET	780-16-JET

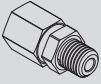

Chaque support est livré avec vis et clé.  
 Jeder Halter wird mit Spannschraube(n)  
 und Schlüssel geliefert.  
 Screw(s) and key are included with each  
 tool holder.

Pièces de rechange Ersatzteile Spare parts			Buse Düse Nozzle 
	Art. N°	Art. N°	Art. N°
770-JET / 780-JET	J-M8X1-D6	JB-M8X1	JJ-M3X6-D1.5

Porte-outils  
Halter  
Holders

Coupe déportée  
Versetzttes Schneiden  
Cut off line

770RC

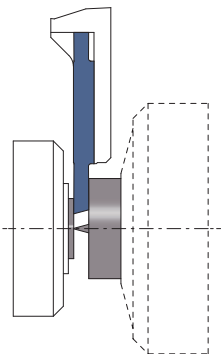
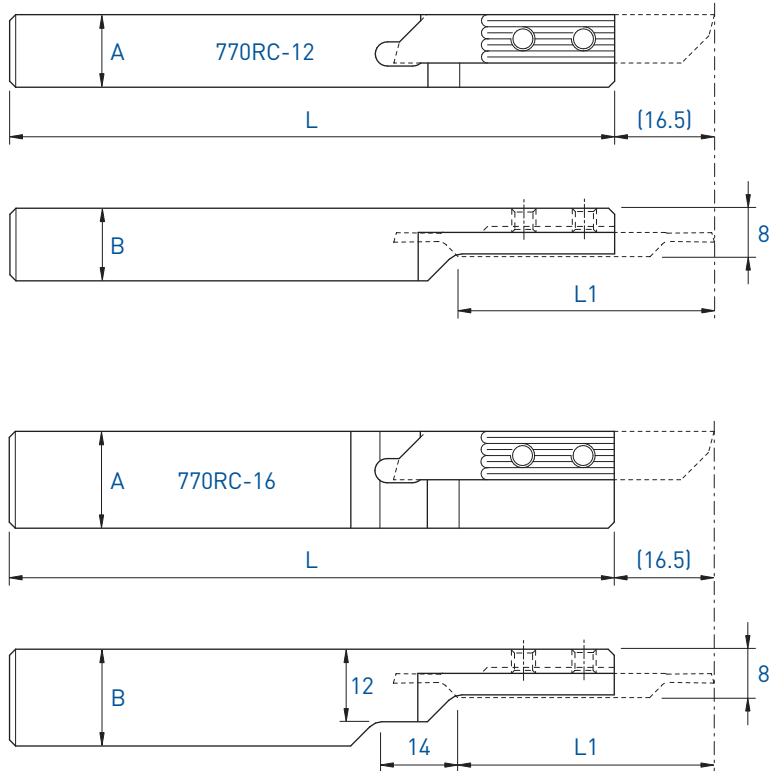

Utiliser des plaquettes type 771R  
WSP Typ 771R verwenden  
Use inserts type 771R

Voir pages 1.138 - 1.141  
Siehe Seiten 1.138 - 1.141  
See pages 1.138 - 1.141

 <b>L (R)</b> Coupe à droite déportée Versetztes Rechtsschneiden Right cut off line				
A x B	L	L1	Serrage Spannsystem Clamping	Art. N°
12 x 12	130	42	A	<b>770RC-12</b>
16 x 16	130	42	A	<b>770RC-16</b>



Chaque support est livré avec vis et clé.  
Jeder Halter wird mit Spannschraube(n) und Schlüssel geliefert.  
Screw(s) and key are included with each tool holder.

Porte-outils

Halter

Holders

7050 / 7060

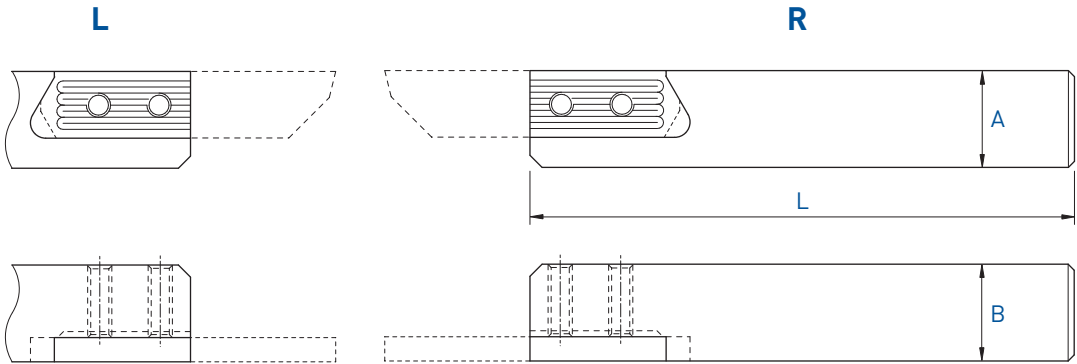

A x B	L	Serrage Spannsystem Clamping		
			Art. N°	Art. N°
16 x 16	130	A	<b>7050-16</b>	<b>7060-16</b>
16 x 16	75	A	<b>7050-16-75</b>	<b>7060-16-75</b>
20 x 20	120	A	<b>7050-20</b>	<b>7060-20</b>
25 x 25	140	A	<b>7050-25</b>	<b>7060-25</b>



Chaque support est livré avec vis et clé.  
Jeder Halter wird mit Spannschraube(n) und Schlüssel geliefert.  
Screw(s) and key are included with each tool holder.

■ = disponible / verfügbar / available

□ = selon disponibilité du stock / jenach Lagerverfügbarkeit / depending on stock availability

Porte-outils

Halter

Holder

W750 / W760

L

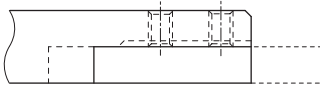
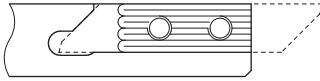

R

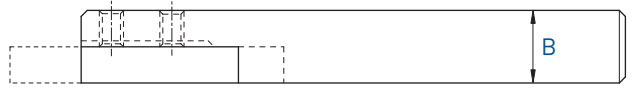
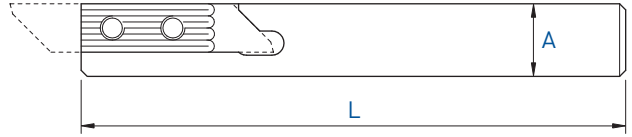

L

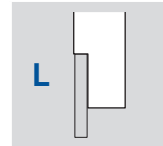

R

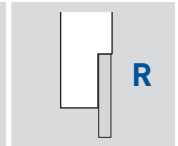

A x B	L	Serrage Spannsystem Clamping	Art. N°	Art. N°
12 x 12	130	A	<b>W750-12</b>	<b>W760-12</b>
16 x 16	130	A	<b>W750-16</b>	<b>W760-16</b>
20 x 20	120	A	<b>W750-20</b>	<b>W760-20</b>



Chaque support est livré avec vis et clé.  
Jeder Halter wird mit Spannschraube(n) und Schlüssel geliefert.  
Screw(s) and key are included with each tool holder.

■ = disponible / verfügbar / available

□ = selon disponibilité du stock / jenach Lagerverfügbarkeit / depending on stock availability

# TOP-LINE

Porte-outils avec arrosage intégré  
 Halter mit integrierter Kühlmittelzufuhr  
 Holders with integrated coolant supply

## W750-JET / W760-JET

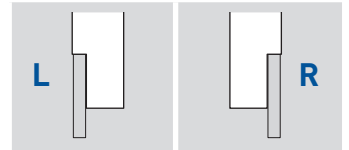
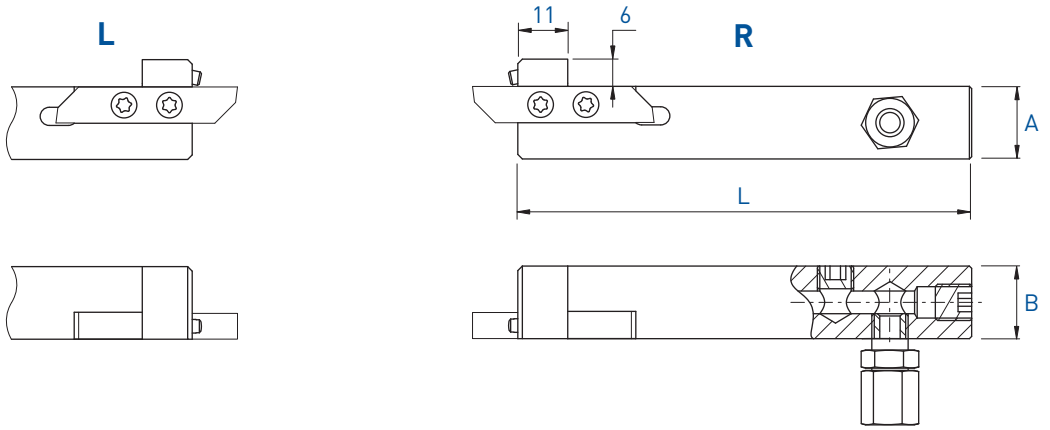

A x B	L	Serrage Spannsystem Clamping	Art. N°	Art. N°
16 x 16	100	A	W750-16-JET	W760-16-JET
20 x 20	100	A	W750-20-JET	W760-20-JET

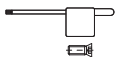

Chaque support est livré avec vis et clé.  
 Jeder Halter wird mit Spannschraube(n)  
 und Schlüssel geliefert.  
 Screw(s) and key are included with each  
 tool holder.

Pièces de rechange Ersatzteile Spare parts	Buse Düse Nozzle		
	Art. N°	Art. N°	Art. N°
W750-JET / W760-JET	J-M8X1-D6	JB-M8X1	JJ-M3X6-D1.5