

Tronçonnage

Abstechen

Parting off

## 731 / 741

L

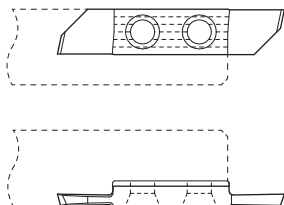

R

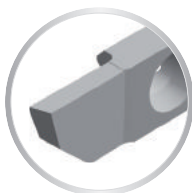
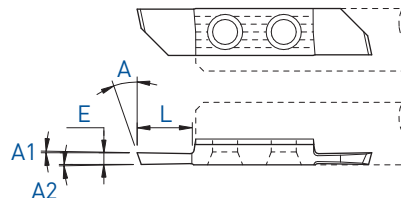

L



R



E	A	A1	A2	L	Art. N°	TiAlN	TiN	N (µk20)	HTA	HTiN	HN (µk10)	Art. N°	TiAlN	TiAlX	TiN	N (µk20)	HTA	HTiN	HN (µk10)			
0.6	18°	2.5°	0.5°	3	731-0.6	■	■	■	■	■	■	741-0.6	■	■	■	■	■	■	■	■		
0.8	20°	0.3°	0.3°	5	731-0.8	■	■	■	■	□	■	741-0.8	■	■	■	■	■	■	■	■		
1.0	20°	0.3°	0.3°	5	731-1.0	■	■	■	■	■	■	741-1.0	■	■	■	■	■	■	■	■		
1.2	20°	0.3°	0.3°	5	731-1.2	■	■	■	■	□	■	741-1.2	■	■	■	■	■	■	■	■		
1.5	20°	0.3°	0.3°	7	731-1.5	■	■	■	■	■	■	741-1.5	■	■	■	■	■	■	■	■		
1.8	20°	0.3°	0.3°	7	731-1.8	■	■	■	■	□	■	741-1.8	■	■	■	■	■	■	■	□	■	
2.0	20°	0.3°	0.3°	7	731-2.0	■	■	■	■	□	■	741-2.0	■	■	■	■	■	■	■	■	■	
2.5	20°	0.3°	0.3°	7	731-2.5	■	■	■	■	■	■	741-2.5	■	■	■	■	■	■	■	■	□	■

7XX-XX-B



Sur demande pour serrage type B, voir page 1.03  
 Wahlweise mit B-Spannsystem, siehe Seite 1.03  
 On request for B clamping system, see page 1.03

Tronçonnage  
Abstechen  
Parting off

731X4 / 741X4

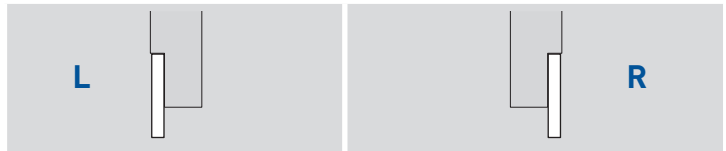
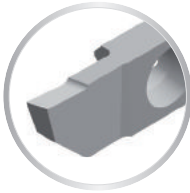
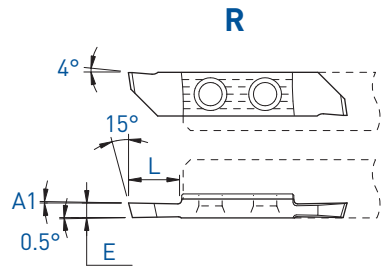
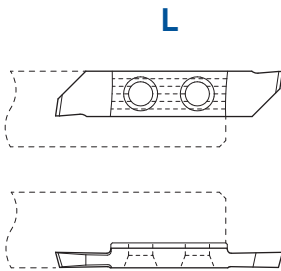

			<b>L</b>				<b>R</b>											
E	A1	L	Art. N°	TiAlN	TiN	N [µk20]	HTA	HTiN	HN [µk10]	Art. N°	TiAlN	TiAlX	TiN	N [µk20]	HTA	HTiN	HN [µk10]	
0.6	2.5°	3	731X4-0.6	■	■	■	■	■	■	741X4-0.6	■	■	■	■	■	■	■	■
0.8	0.5°	4	-							741X4-0.8					■		■	
1.0	0.5°	5	731X4-1.0	■	■	■				741X4-1.0	■	■	■	■	■	□	■	
1.5	0.5°	7	731X4-1.5	■	■	■	■	□	■	741X4-1.5	■	■	■	■	■	□	■	
2.0	0.5°	7	731X4-2.0	■	■	■				741X4-2.0	■	■	■	■				

7XX-XX-B

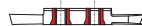

Sur demande pour serrage type B, voir page 1.03  
Wahlweise mit B-Spannsystem, siehe Seite 1.03  
On request for B clamping system, see page 1.03

■ = disponible / verfügbar / available  
□ = selon disponibilité du stock / jenach Lagerverfügbarkeit / depending on stock availability

# TOP-LINE

- Tronçonnage
- Abstechen
- Parting off

## 731XF / 741XF

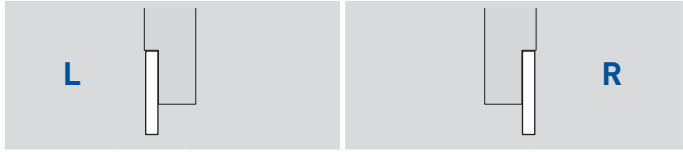
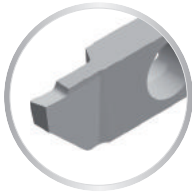
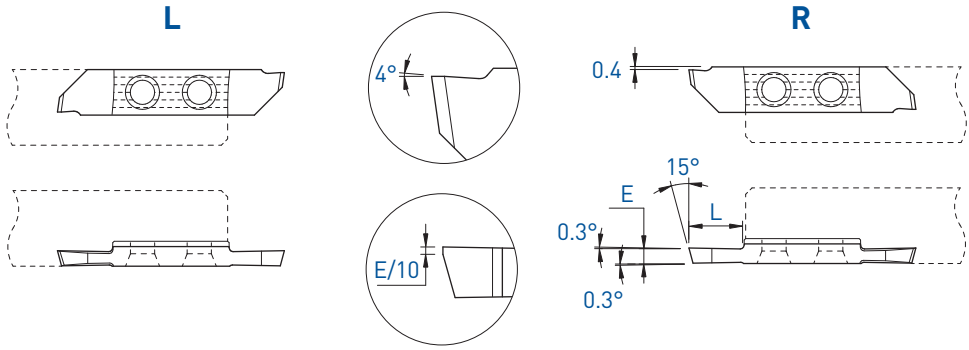

E	L	Art. N°	L			R									
			TiAlN	TiN	N (µk20)	HTA	HTiN	HN (µk10)	Art. N°	TiAlN	TiN	N (µk20)	HTA	HTiN	HN (µk10)
1.2	5	-							741XF-1.2	■	□	■			
1.5	7	731XF-1.5	■	■	■	■	■	■	741XF-1.5	■	■	■	■	■	■
2.0	7	731XF-2.0	■	■	■				741XF-2.0	■	■	■	■	■	■
2.5	7	731XF-2.5	■	■	■				741XF-2.5	■	■	■			

7XX-XX-B



Sur demande pour serrage type B, voir page 1.03  
 Wahlweise mit B-Spannsystem, siehe Seite 1.03  
 On request for B clamping system, see page 1.03

Tronçonnage

Abstechen

Parting off

731X12 / 741X12

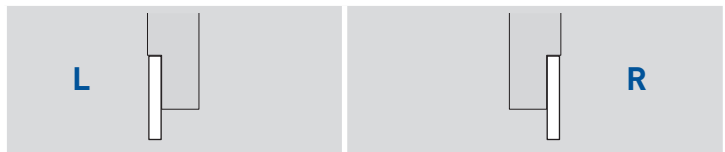
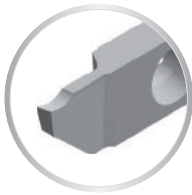
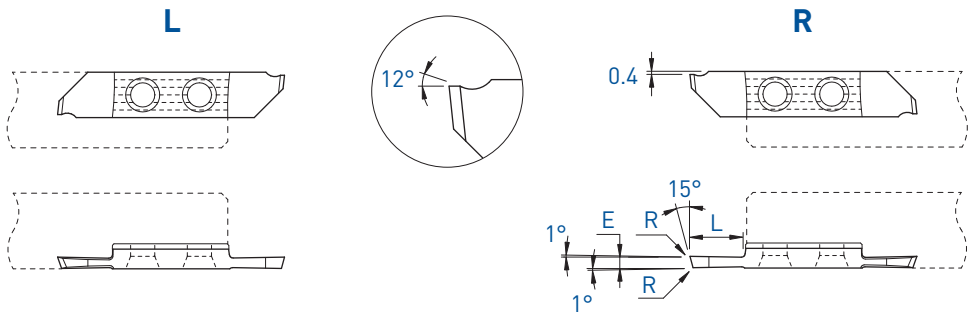

E	L	R	Art. N°	TiAlN	TiN	N (µk20)	HTA	HTiN	HN (µk10)	Art. N°	TiAlN	TiAlX	TiN	N (µk20)	HTA	HTiN	HN (µk10)
0.5	3	0.03	-							741X12-0.5					■		■
1.0	5	0.03	731X12-1.0	■	■	■				741X12-1.0	■	■	■	■	■	□	■
1.5	7	0.03	731X12-1.5	■	■	■				741X12-1.5	■	■	■	■	■	■	■
2.0	7	0.03	731X12-2.0	■	■	■				741X12-2.0	■	■	■	■	■	□	■

7XX-XX-B



Sur demande pour serrage type B, voir page 1.03  
Wahlweise mit B-Spannsystem, siehe Seite 1.03  
On request for B clamping system, see page 1.03

■ = disponible / verfügbar / available

□ = selon disponibilité du stock / jenach Lagerverfügbarkeit / depending on stock availability

Tronçonnage  
Abstechen  
Parting off

## 731X25 / 741X25

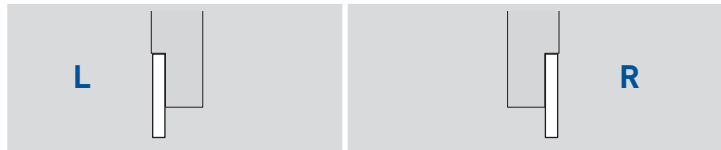
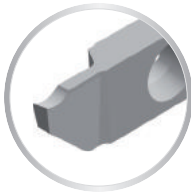
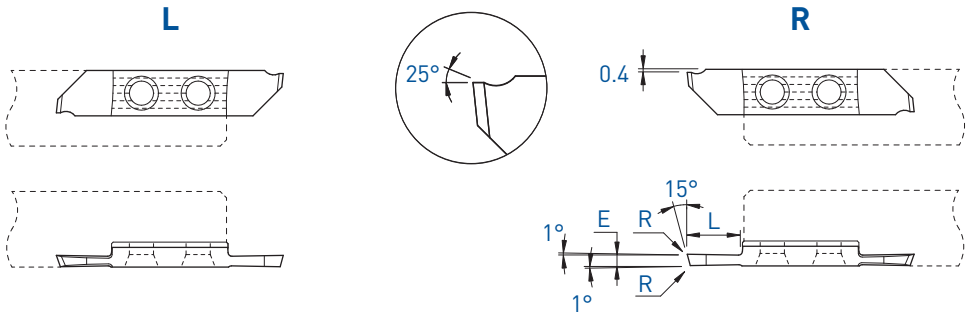

E	L	Art. N°	L			R			Art. N°	R						
			TiAlN	TiN	N (µk20)	HTA	HTiN	HN (µk10)		TiAlN	TiAlX	TiN	N (µk20)	HTA	HTiN	HN (µk10)
1.0	5	731X25-1.0	■	■	■				741X25-1.0	■		■	■	■	□	■
1.5	7	731X25-1.5	■	■	■				741X25-1.5	■		■	■	■	□	■
2.0	7	731X25-2.0	■	■	■				741X25-2.0	■	■	■	■	■	□	■

7XX-XX-B

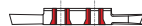

Sur demande pour serrage type B, voir page 1.03  
Wahlweise mit B-Spannsystem, siehe Seite 1.03  
On request for B clamping system, see page 1.03

Tronçonnage

Abstechen

Parting off

731U / 741U

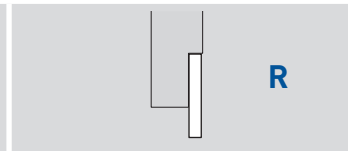
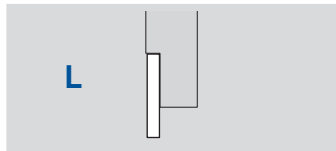
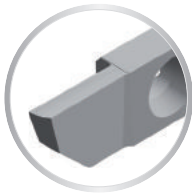
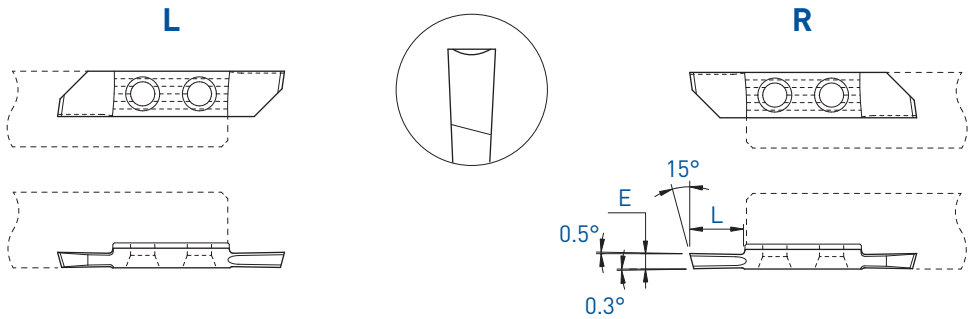

E	L	Art. N°	TiAlN	TiN	N (µk20)	HTA	HTiN	HN (µk10)	Art. N°	TiAlN	TiN	N (µk20)	HTA	HTiN	HN (µk10)
1.5	7	731U-1.5	■	■	■	■	□	■	741U-1.5	■	■	■	■	■	■
2.0	7	731U-2.0	■	■	■	■	□	■	741U-2.0	■	■	■	■	□	■

7XX-XX-B



Sur demande pour serrage type B, voir page 1.03  
Wahlweise mit B-Spannsystem, siehe Seite 1.03  
On request for B clamping system, see page 1.03

■ = disponible / verfügbar / available

□ = selon disponibilité du stock / jenach Lagerverfügbarkeit / depending on stock availability

Tronçonnage

Abstechen

Parting off

## 731N / 741N

L

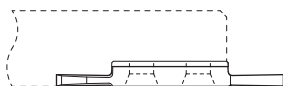
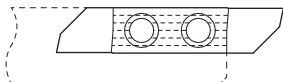

R

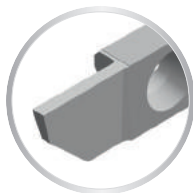
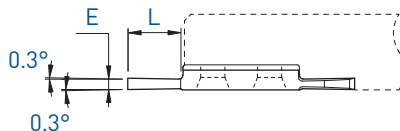
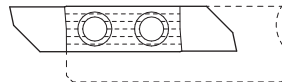

L



R



E	L	Art. N°	TiAlN	TiN	N (µk20)	HTA	HTiN	HN (µk10)	Art. N°	TiAlN	TiN	N (µk20)	HTA	HTiN	HN (µk10)
1.0	5	731N-1.0	■	■	■	■	□	■	741N-1.0	■	■	■	■	□	■
1.5	7	731N-1.5	■	■	■	■	□	■	741N-1.5	■	■	■	■	□	■

7XX-XX-B



Sur demande pour serrage type B, voir page 1.03  
Wahlweise mit B-Spannsystem, siehe Seite 1.03  
On request for B clamping system, see page 1.03