

APPLITEC

TOOLING-Line

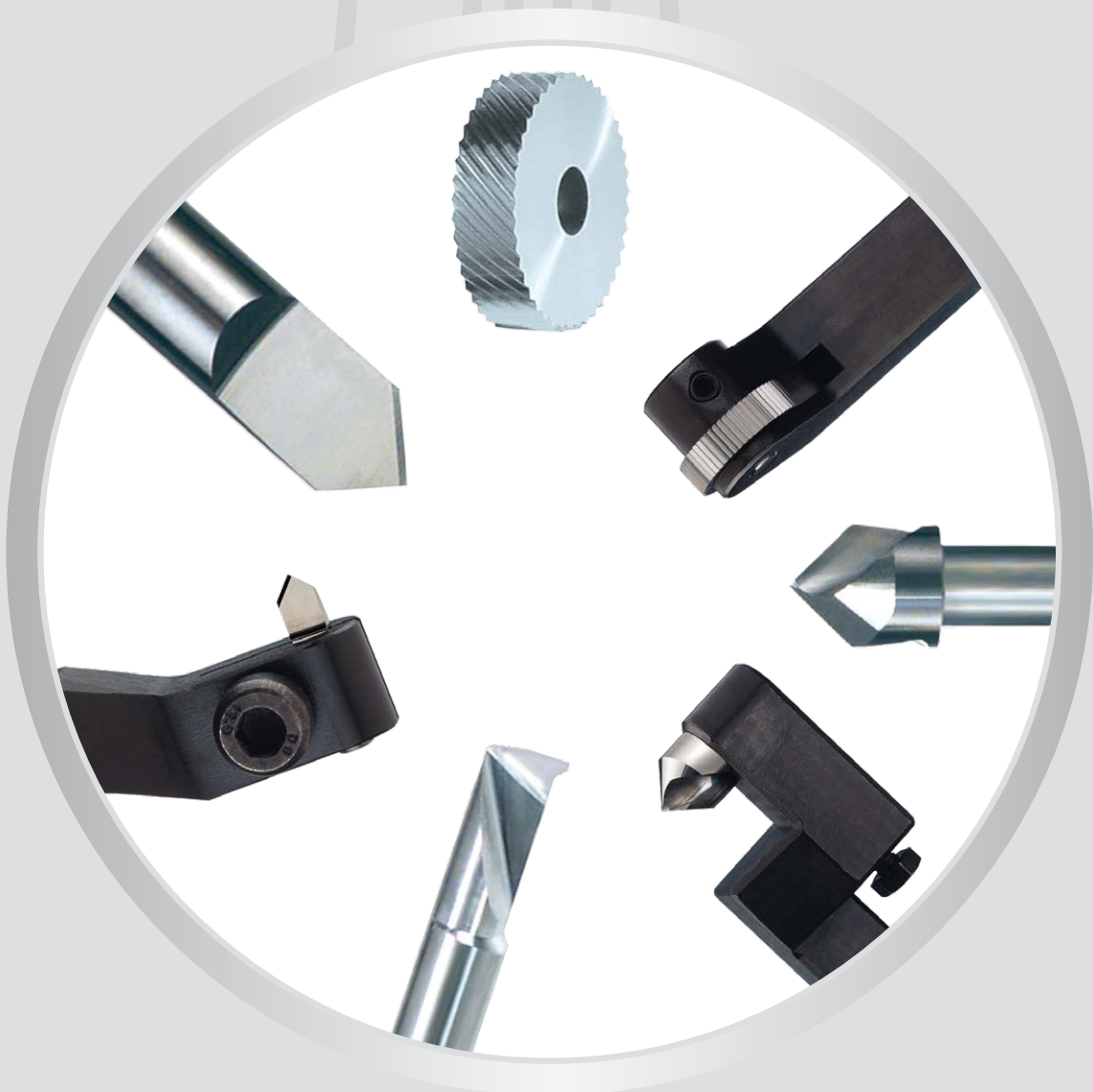

APPLITEC
SWISS TOOLING

TOOLING-Line

Porte-outils
Werkzeughalter
Tool holders

1400-J / 2400-J

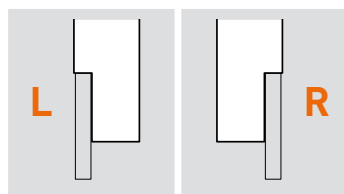
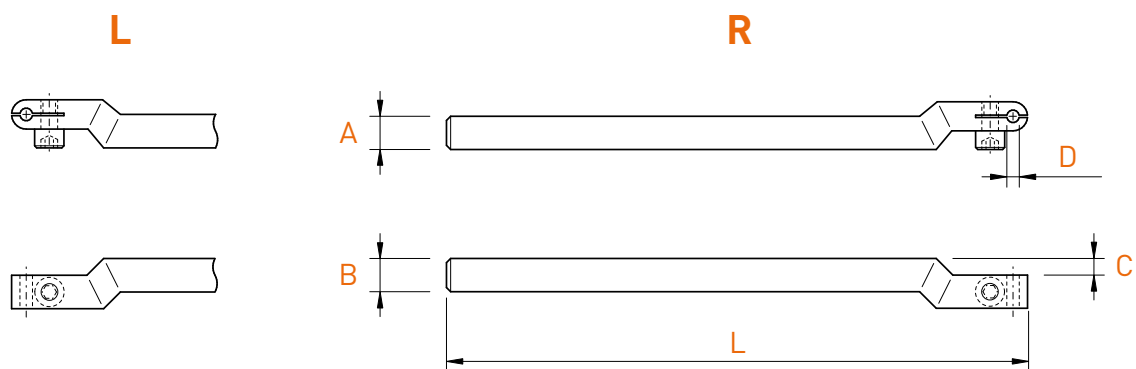

A x B	L	C	D	Art. N°	Art. N°
6 x 6	132	3	1.5	1400-J-615	2400-J-615
6 x 6	132	3	2.0	1400-J-620	2400-J-620
6 x 6	132	3	3.0	1400-J-630	2400-J-630
7 x 7	140	3	1.5	1400-J-715	2400-J-715
7 x 7	140	3	2.0	1400-J-720	2400-J-720
7 x 7	140	3	3.0	1400-J-730	2400-J-730
8 x 8	140	4	1.5	1400-J-815	2400-J-815
8 x 8	140	4	2.0	1400-J-820	2400-J-820
8 x 8	140	4	3.0	1400-J-830	2400-J-830

Porte-outils
Werkzeughalter
Tool holders

1401-K / 2401-K

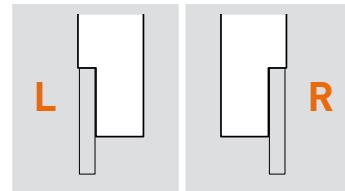
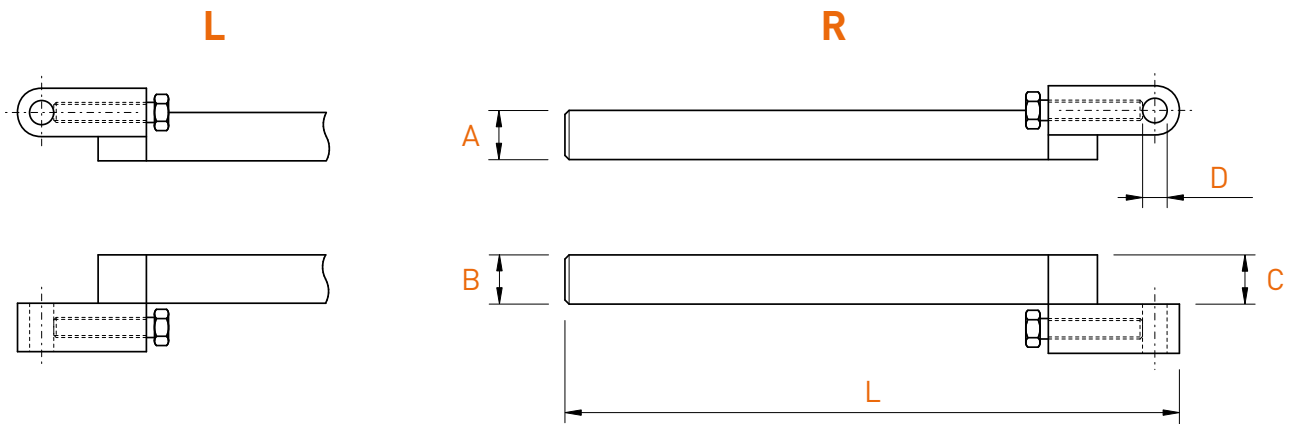

A x B	L	C	D	Art. N°	Art. N°
7 x 7	146	7	2.0	1401-K-720	-
7 x 7	146	7	3.0	1401-K-730	2401-K-730
7 x 7	146	7	4.0	1401-K-740	2401-K-740
8 x 8	146	8	2.0	1401-K-820	-
8 x 8	146	8	3.0	1401-K-830	2401-K-830
8 x 8	146	8	4.0	1401-K-840	2401-K-840
8 x 8	146	8	5.0	1401-K-850	2401-K-850
8 x 8	146	8	6.0	1401-K-860	2401-K-860
10 x 10	150	10	3.0	-	2401-K-1030
10 x 10	150	10	4.0	1401-K-1040	2401-K-1040
10 x 10	150	10	5.0	1401-K-1050	2401-K-1050
10 x 10	150	10	6.0	1401-K-1060	2401-K-1060
10 x 10	150	10	7.0	1401-K-1070	2401-K-1070
12 x 12	150	12	3.0	-	2401-K-1230
12 x 12	150	12	4.0	1401-K-1240	2401-K-1240
12 x 12	150	12	5.0	1401-K-1250	2401-K-1250
12 x 12	150	12	6.0	1401-K-1260	2401-K-1260
12 x 12	150	12	8.0	1401-K-1280	2401-K-1280
14 x 14	150	14	4.0	1401-K-1440	2401-K-1440
14 x 14	150	14	6.0	1401-K-1460	2401-K-1460
14 x 14	150	14	8.0	1401-K-1480	2401-K-1480

TOOLING-Line

Porte-outils

Werkzeughalter

Tool holders

1420 / 2420

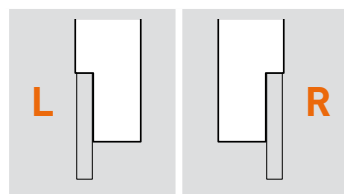
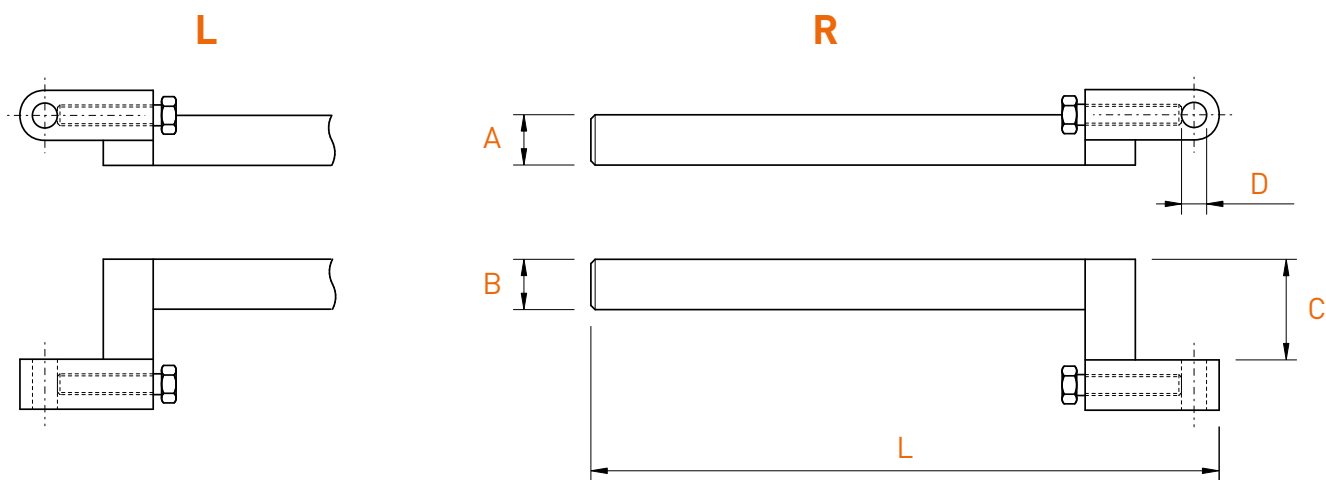

A x B	L	C	D	Art. N°	Art. N°
7 x 7	146	12	4.0	1420-7124	2420-7124
8 x 8	146	12	4.0	1420-8124	2420-8124
8 x 8	146	14	3.0	1420-8143	2420-8143
8 x 8	146	15	5.0	1420-8155	2420-8155
8 x 8	146	20	5.0	1420-8205	2420-8205
10 x 10	150	20	6.0	1420-10206	2420-10206
12 x 12	150	18	6.0	1420-12186	2420-12186
12 x 12	150	18	8.0	1420-12188	-
12 x 12	150	24	8.0	1420-12248	2420-12248
14 x 14	150	20	8.0	1420-14208	2420-14208
14 x 14	150	24	8.0	1420-14248	2420-14248

Porte-outils

Werkzeughalter

Tool holders

∅ 12 x 12

1460

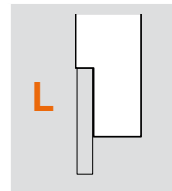
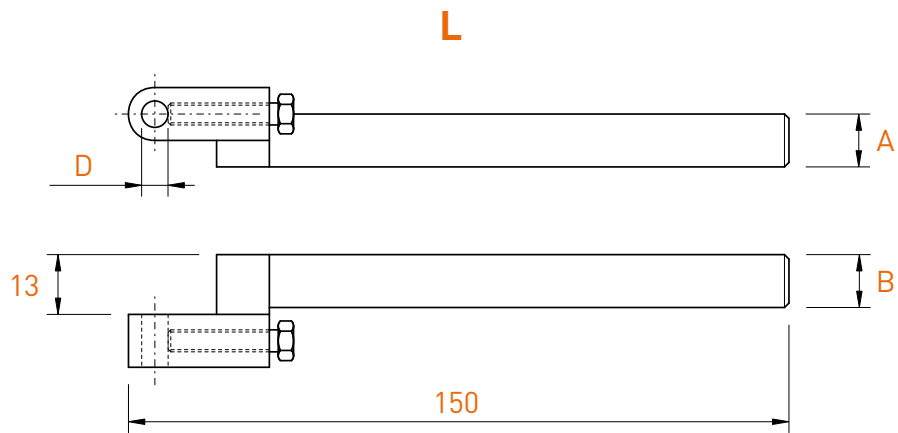

A x B	D	Art. N°
12 x 12	4.0	1460-4
12 x 12	5.0	1460-5
12 x 12	6.0	1460-6
12 x 12	8.0	1460-8

TOOLING-Line

Porte-outils

Werkzeughalter

Tool holders

∅ 10 x 10

2450-SP

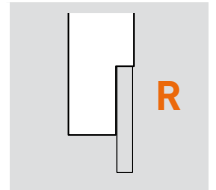
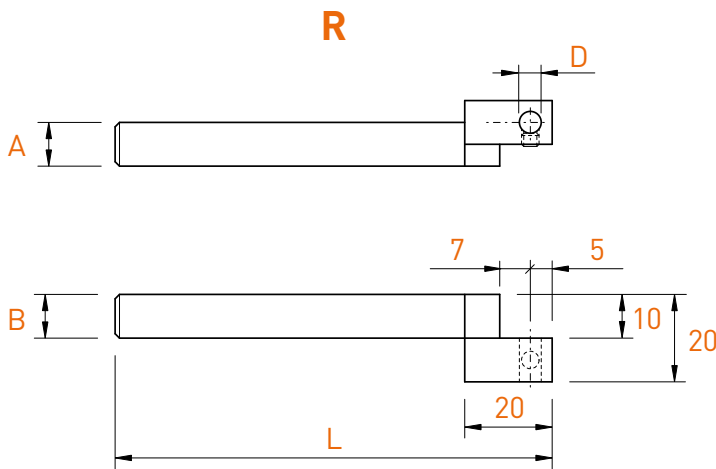

A x B	L	D	Art. N°
10 x 10	100	3.0	2450-SP-3
10 x 10	100	4.0	2450-SP-4
10 x 10	100	5.0	2450-SP-5
10 x 10	100	6.0	2450-SP-6
10 x 10	120	3.0	2450-SP-3-120
10 x 10	120	4.0	2450-SP-4-120
10 x 10	120	5.0	2450-SP-5-120
10 x 10	120	6.0	2450-SP-6-120

Porte-outils

Werkzeughalter

Tool holders

∅ 10 x 10

2470

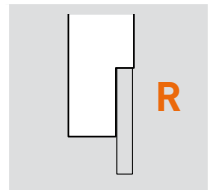
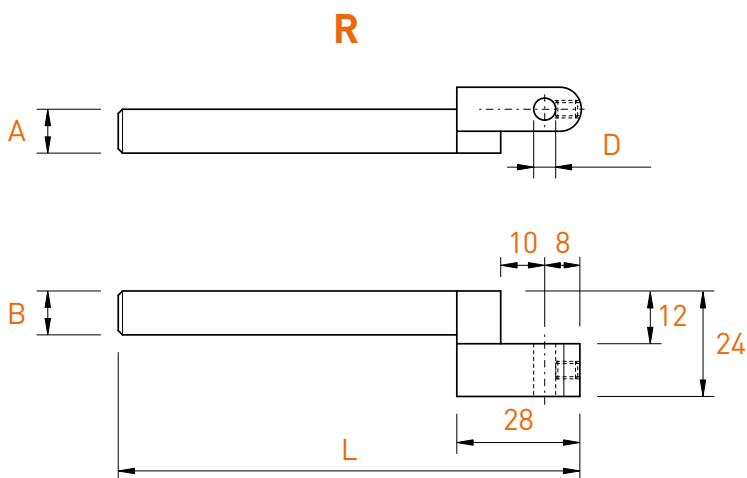

A x B	L	D	Art. N°
10 x 10	105	3.0	2470-3
10 x 10	105	4.0	2470-4
10 x 10	105	5.0	2470-5
10 x 10	105	6.0	2470-6
10 x 10	105	7.0	2470-7

Porte-outils
Werkzeughalter
Tool holders

∅ 12 x 12

2450

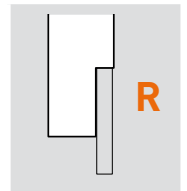
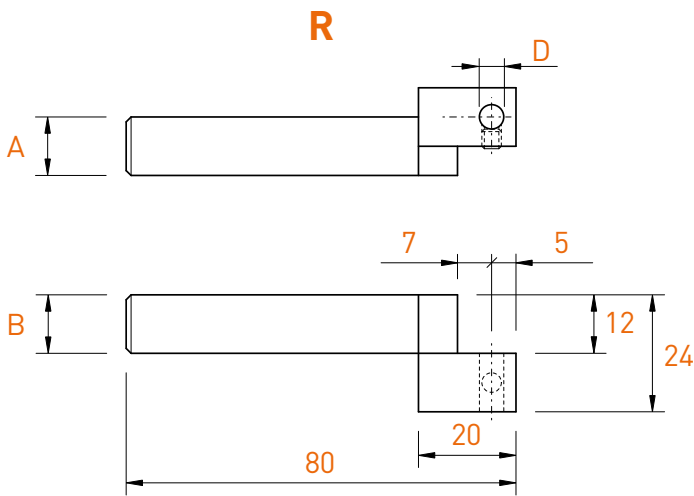

A x B	D	Art. N°
12 x 12	3.0	2450-3
12 x 12	4.0	2450-4
12 x 12	5.0	2450-5
12 x 12	6.0	2450-6
12 x 12	8.0	2450-8

Porte-outils
Werkzeughalter
Tool holders

∅ 12 x 12

2460

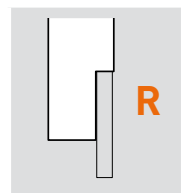
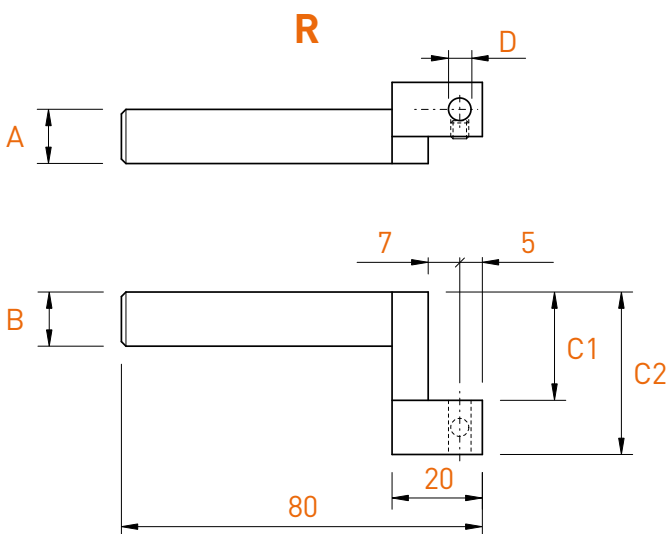

A x B	C1	C2	D	Art. N°
12 x 12	16	28	4.0	2460-284
12 x 12	16	28	6.0	2460-286
12 x 12	16	28	8.0	2460-288
12 x 12	20	32	4.0	2460-324
12 x 12	20	32	6.0	2460-326
12 x 12	20	32	8.0	2460-328
12 x 12	24	36	4.0	2460-364
12 x 12	24	36	6.0	2460-366
12 x 12	24	36	8.0	2460-368

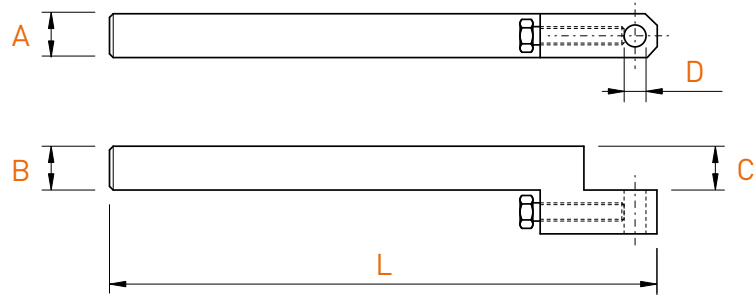

A x B	L	C	D	Art. N°
8 x 8	120	8	3.0	2405-K-830
8 x 8	120	8	4.0	2405-K-840
8 x 8	120	8	5.0	2405-K-850
8 x 8	120	8	6.0	2405-K-860
10 x 10	100	10	4.0	2405-K-1040
10 x 10	100	10	5.0	2405-K-1050
10 x 10	100	10	6.0	2405-K-1060
12 x 12	150	12	4.0	2405-K-1240
12 x 12	150	12	6.0	2405-K-1260
12 x 12	150	12	8.0	2405-K-1280

Porte-outils

Werkzeughalter

Tool holders

2425

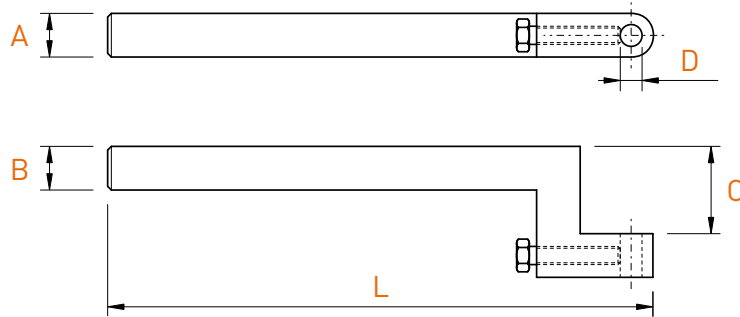

A x B	L	C	D	Art. N°
8 x 8	120	12	4.0	2425-8124
8 x 8	120	15	5.0	2425-8155
8 x 8	120	20	5.0	2425-8205
10 x 10	100	15	6.0	2425-10156
10 x 10	100	20	6.0	2425-10206
12 x 12	150	18	6.0	2425-12186
12 x 12	150	24	8.0	2425-12248

TOOLING-Line

Porte-outils
Werkzeughalter
Tool holders

12 x 16

2441

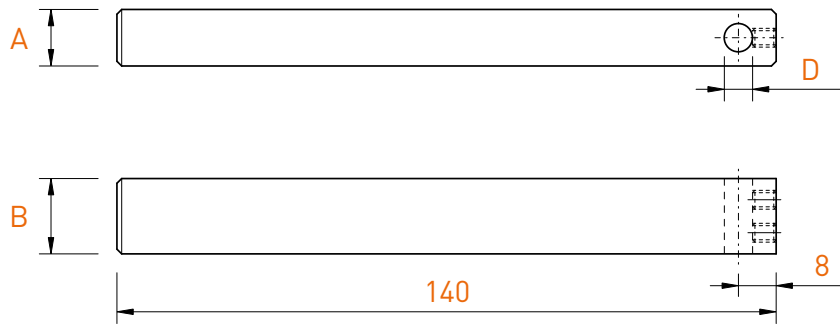

A x B	D	Art. N°
12 x 16	3.0	2441-0-3
12 x 16	4.0	2441-0-4
12 x 16	5.0	2441-0-5
12 x 16	6.0	2441-0-6

Porte-outils
Werkzeughalter
Tool holders

∅ 16 x 16

2440-0



A x B	D	Art. N°
16 x 16	3.0	2440-0-3
16 x 16	4.0	2440-0-4
16 x 16	5.0	2440-0-5
16 x 16	6.0	2440-0-6

Porte-outils

Werkzeughalter

Tool holders

∅ 16 x 16

2440-8 / 2440-12

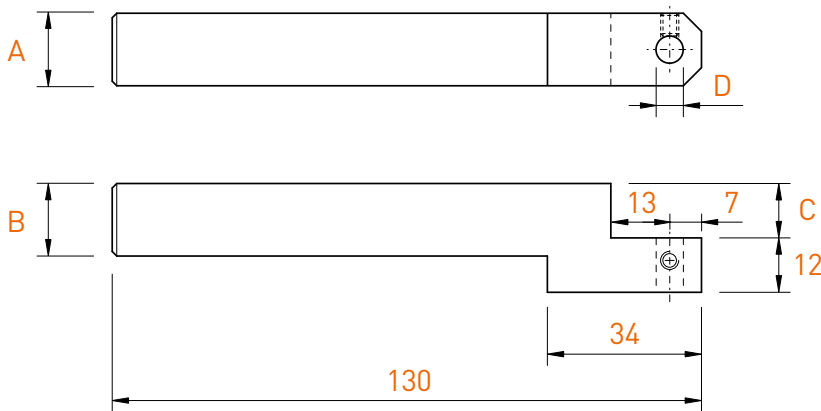

A x B	C	D	Art. N°
16 x 16	8	3.0	2440-8-3
16 x 16	8	4.0	2440-8-4
16 x 16	8	5.0	2440-8-5
16 x 16	8	6.0	2440-8-6
16 x 16	8	8.0	2440-8-8
16 x 16	12	3.0	2440-12-3
16 x 16	12	4.0	2440-12-4
16 x 16	12	5.0	2440-12-5
16 x 16	12	6.0	2440-12-6
16 x 16	12	8.0	2440-12-8

Porte-outils

Werkzeughalter

Tool holders

∅ 16 x 16

2440-18 / 2440-26

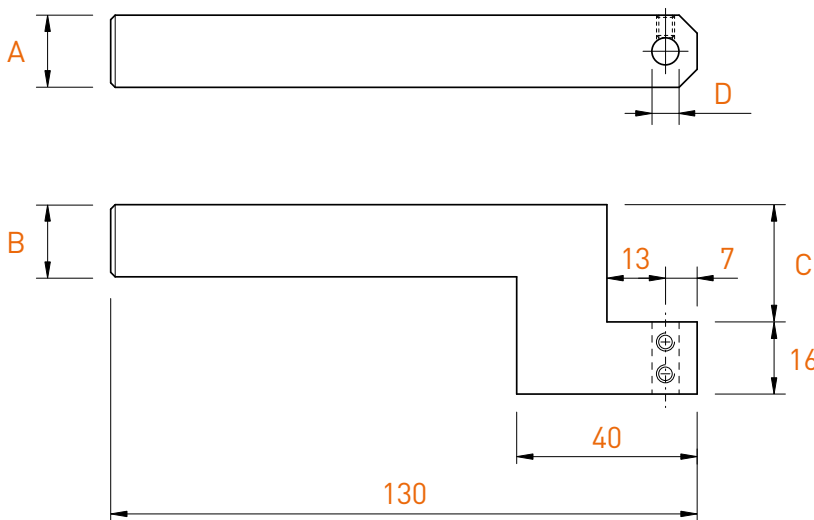

A x B	C	D	Art. N°
16 x 16	18	4.0	2440-18-4
16 x 16	18	5.0	2440-18-5
16 x 16	18	6.0	2440-18-6
16 x 16	18	8.0	2440-18-8
16 x 16	26	4.0	2440-26-4
16 x 16	26	5.0	2440-26-5
16 x 16	26	6.0	2440-26-6
16 x 16	26	8.0	2440-26-8

TOOLING-Line

Porte-outils pour machines Tornos DECO 7/10

Werkzeughalter für Tornos DECO 7/10 Maschinen

Tool holders for Tornos DECO 7/10 machines

2435 / 2435-T

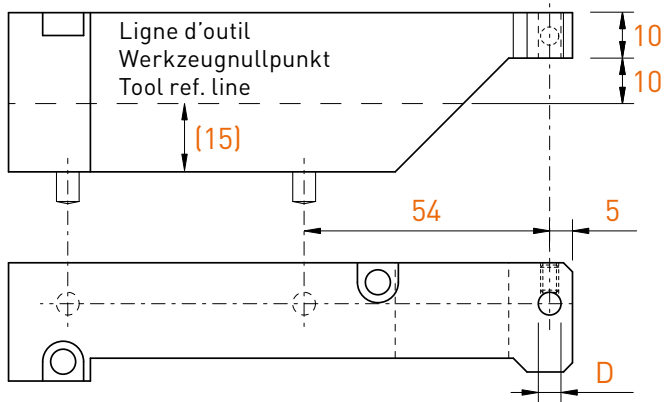

D	Art. N°
3.0	2435-3
4.0	2435-4
5.0	2435-5
6.0	2435-6

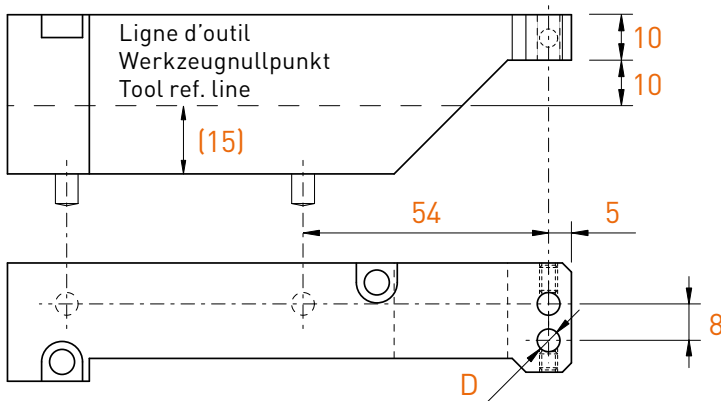

D (2x)	Art. N°
3.0	2435-3-T
4.0	2435-4-T
5.0	2435-5-T
6.0	2435-6-T

Porte-outils pour machines Tornos DECO 13 / EvoDECO 16

Werkzeughalter für Tornos DECO 13 / EvoDECO 16 Maschinen

Tool holders for Tornos DECO 13 / EvoDECO 16 machines

2436 / 2436-T

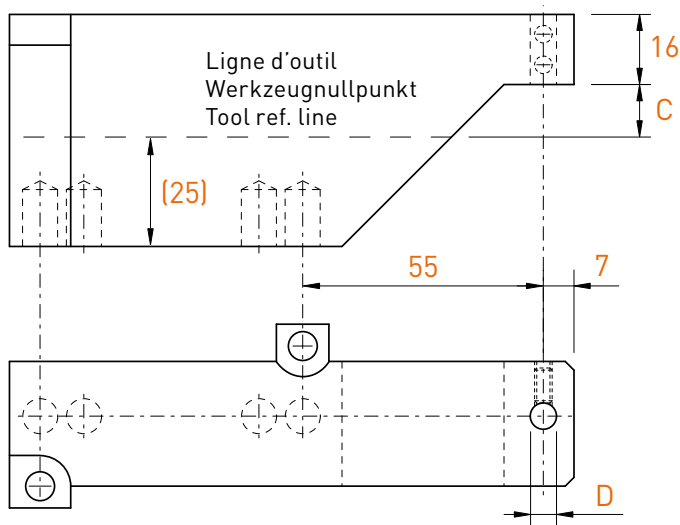

C	D	Art. N°
12	3.0	2436-12-3
12	4.0	2436-12-4
12	5.0	2436-12-5
12	6.0	2436-12-6
12	8.0	2436-12-8
18	3.0	2436-18-3
18	4.0	2436-18-4
18	5.0	2436-18-5
18	6.0	2436-18-6
18	8.0	2436-18-8

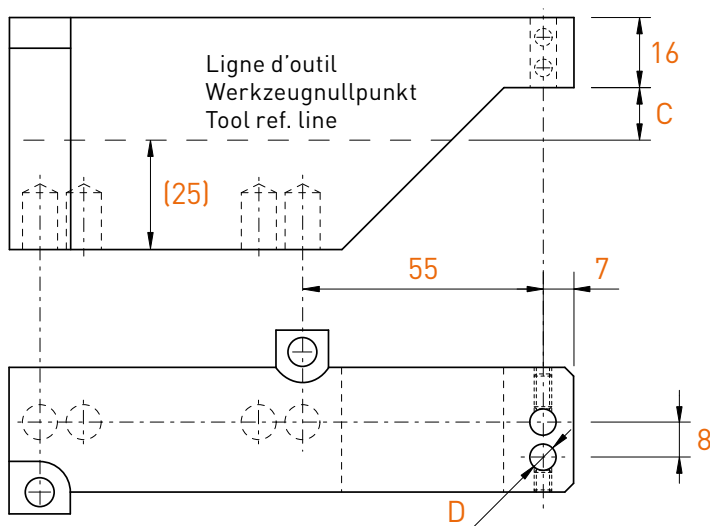

C	D (2x)	Art. N°
12	3.0	2436T-12-3
12	4.0	2436T-12-4
12	5.0	2436T-12-5
12	6.0	2436T-12-6
18	3.0	2436T-18-3
18	4.0	2436T-18-4
18	5.0	2436T-18-5
18	6.0	2436T-18-6

Entretoise

Erhöhungplatte

Spacer

2436-S12

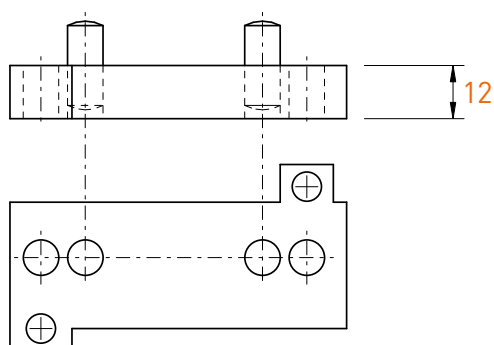

Art. N°

2436-S12

PERFORMANCE | PRECISION | RIGIDITY



SWISS MADE



APPLITEC
SWISS TOOLING

Applitec Moutier S.A.
Ch. Nicolas-Junker 2
CH-2740 Moutier

Tél. +41 32 494 60 20
Fax +41 32 493 42 60
www.applitec-tools.com